



Name \_\_\_\_\_

22

# 1<sup>st</sup> Grade ELA Remote Learning Packet

## Week 22



Dear Educator,

My signature is proof that I have reviewed my scholar's work and supported him to the best of my ability to complete all assignments.

\_\_\_\_\_  
(Parent Signature)

\_\_\_\_\_  
(Date)

Parents please note that all academic packets are also available on our website at [www.brighterchoice.org](http://www.brighterchoice.org) under the heading "Remote Learning." All academic packet assignments are mandatory and must be completed by all scholars.



# Day # 1

**February Break**

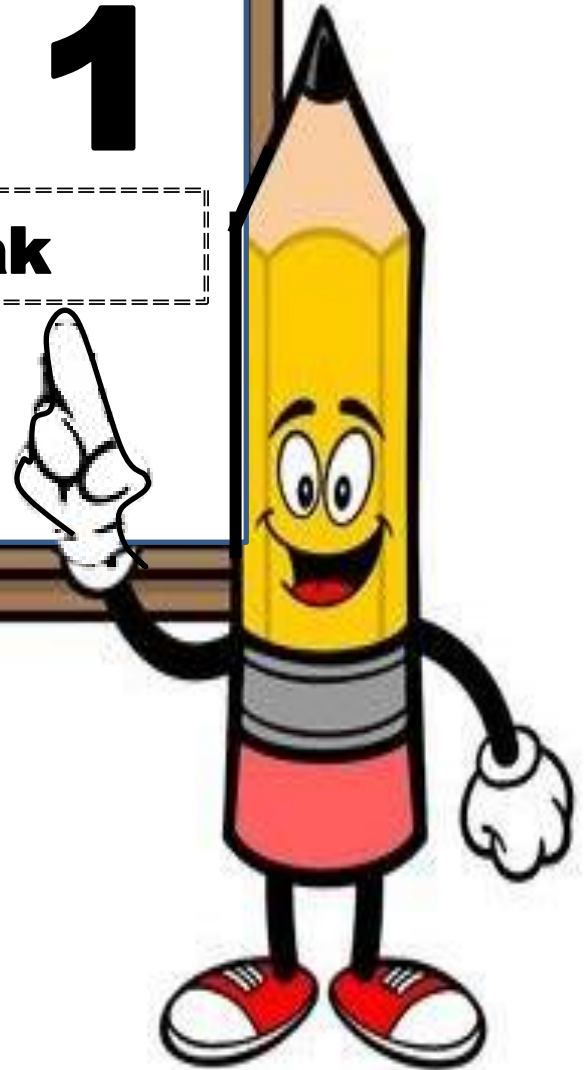

Name: \_\_\_\_\_ Week 22 Day 1 Date: \_\_\_\_\_  
BCCS-B RPI SIENA UNION

### February Break Packet

Directions: List the objects that you see in the picture. Then color the picture.

1. \_\_\_\_\_
2. \_\_\_\_\_
3. \_\_\_\_\_
4. \_\_\_\_\_
5. \_\_\_\_\_

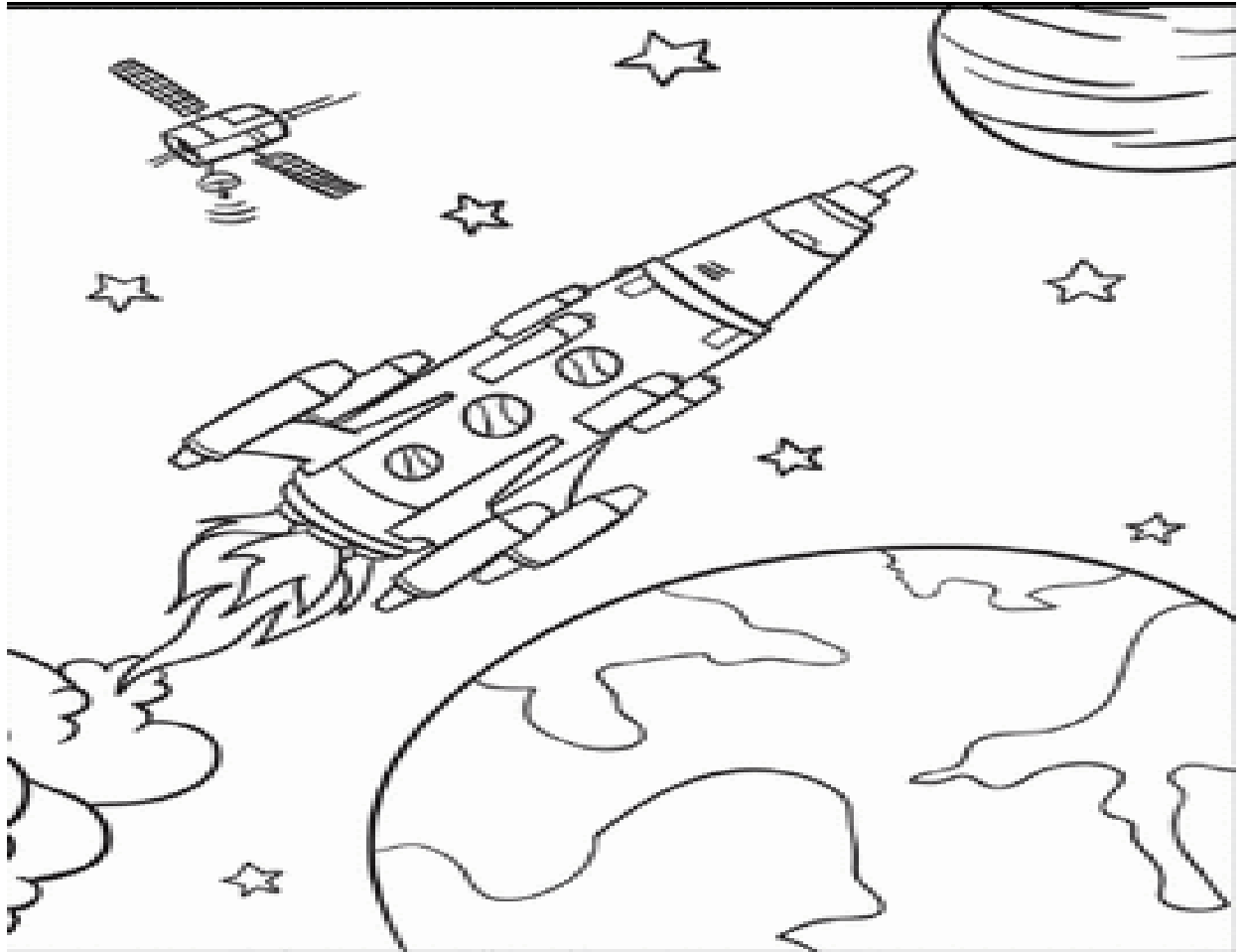



# Day # 2

**February Break**

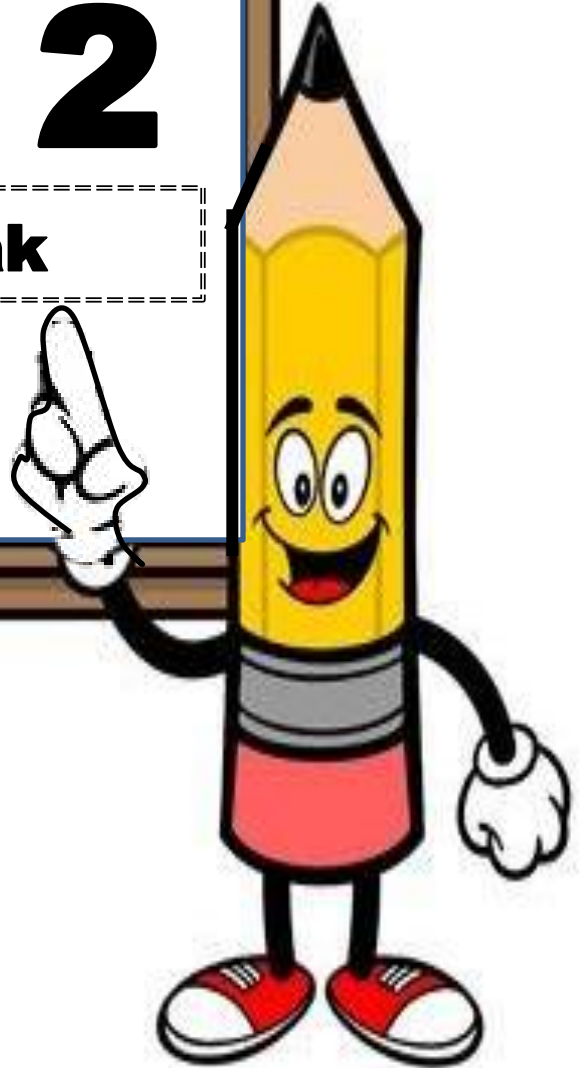

Name: \_\_\_\_\_ Week 22 Day 2 Date: \_\_\_\_\_  
BCCS-B RPI SIENA UNION

**February Break Packet**

Find the hidden sight words.

<b>AN</b>	<b>WHEN</b>	<b>STOP</b>	<b>OPEN</b>	<b>HAD</b>
-----------	-------------	-------------	-------------	------------

D	H	B	N	V	X	A	W
D	S	T	O	P	I	V	H
H	M	F	L	O	P	N	E
A	R	O	U	N	D	O	N
D	K	E	W	S	Y	B	T
M	S	R	C	O	U	L	H
Q	P	S	I	M	A	G	O
O	P	E	N	R	N	D	N



# Day # 3

February Break

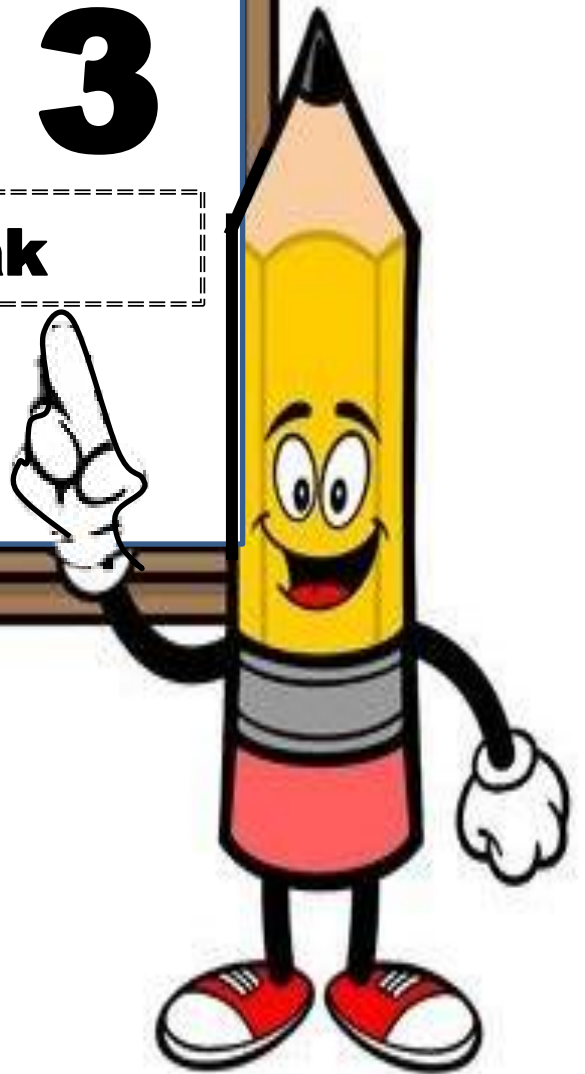

**February Break Packet**

**Directions:** Read the story and answer the questions.

**Tommy the Tiger**

Tommy is a happy tiger. He loves to run fast. Tommy lives in the jungle. Tommy has stripes all over his body. Tommy has two little tiger cubs that he looks after.



**1. What is the tiger's name?**  
 A Tommy       B Tony       C Tito

**2. What is Tommy like?**  
 A Sad       B Happy       C Tired

**3. How many cubs does he have?**  
 A One       B Three       C Two

**4. What does Tommy have on his body?**  
 A Insects       B Stripes       C Faint

**5. Where does Tommy live?**  
 A The Jungle       B The Park       C School



**Day # 4**

**February Break**

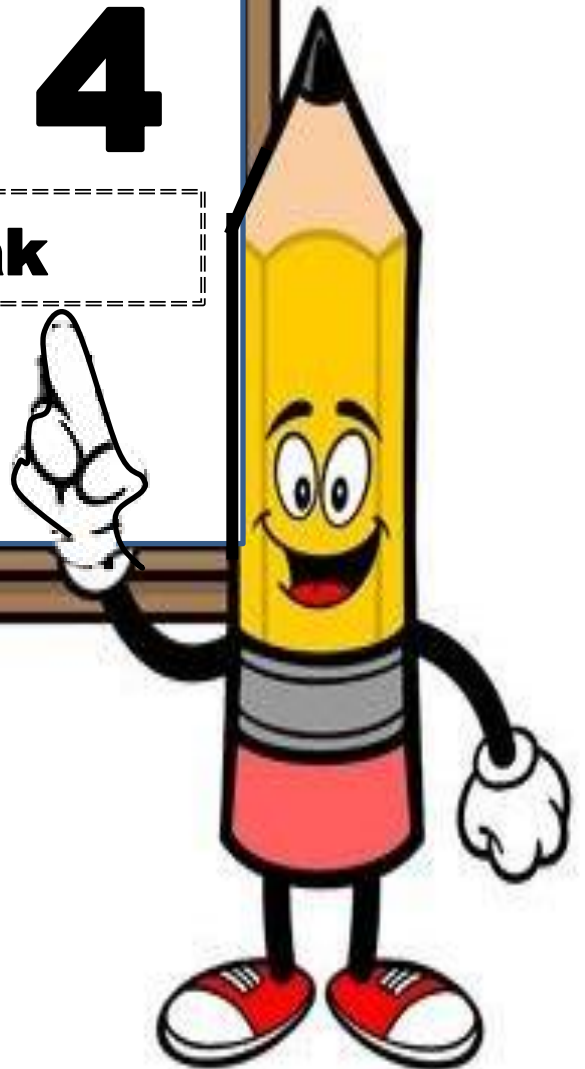



**February Break Packet**

**Directions:** Read the sentence and choose the pronoun that completes the sentences

\_\_\_\_\_ have a frog named Bob. 

When I play in the rain, \_\_\_\_\_ comes with me. 

Sometimes my mom lets \_\_\_\_\_ play in the mud. 

\_\_\_\_\_ jump in puddles and make big splashes. 

\_\_\_\_\_ get all over my boots. 

When my mom calls, \_\_\_\_\_ have to go inside. 

\_\_\_\_\_ tells me and Bob to wash up so we don't get mud on the rug. 



**Day # 5**

**February Break**

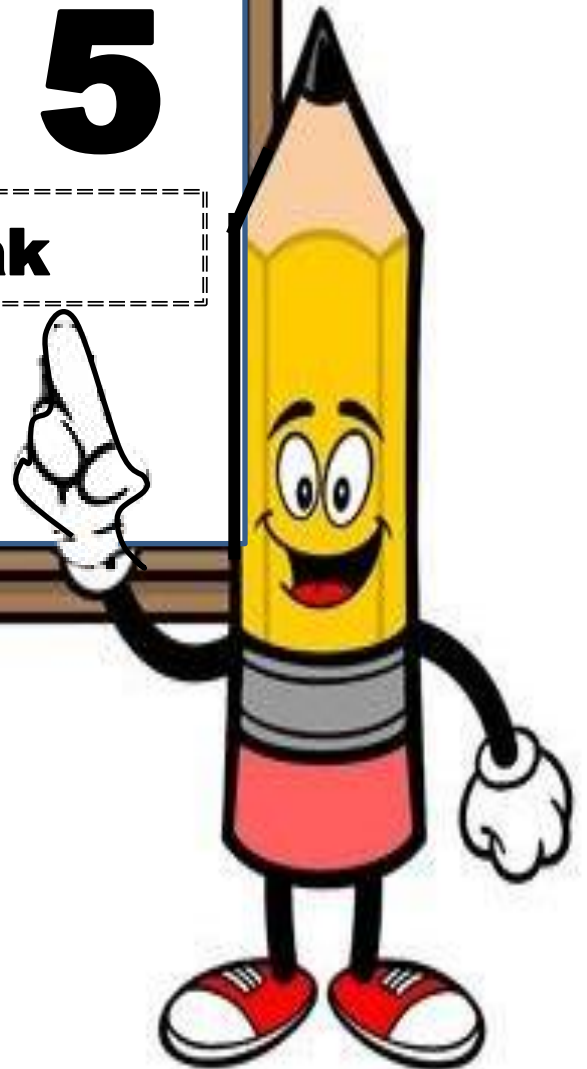

**February Break Packet**

**Directions:** Read the sentence and choose a word from the word bank that completes the sentence.

gate    cake    vase    rake  
tape    game    cave    cage

I can play a \_\_\_\_\_ 

Did you close the \_\_\_\_\_? 

The \_\_\_\_\_ is pretty. 

Put the bird in its \_\_\_\_\_ 

I like my birthday \_\_\_\_\_ 

The bear is in the \_\_\_\_\_ 

Use the \_\_\_\_\_ to clean! 

Do you see the \_\_\_\_\_? 



Name \_\_\_\_\_



# 1<sup>st</sup> Grade ELA Remote Learning Packet

## Week 23



Dear Educator,

My signature is proof that I have reviewed my scholar’s work and supported him to the best of my ability to complete all assignments.

\_\_\_\_\_  
(Parent Signature)

\_\_\_\_\_  
(Date)

Parents please note that all academic packets are also available on our website at [www.brighterchoice.org](http://www.brighterchoice.org) under the heading “Remote Learning.” All academic packet assignments are mandatory and must be completed by all scholars.



**Day # 1**

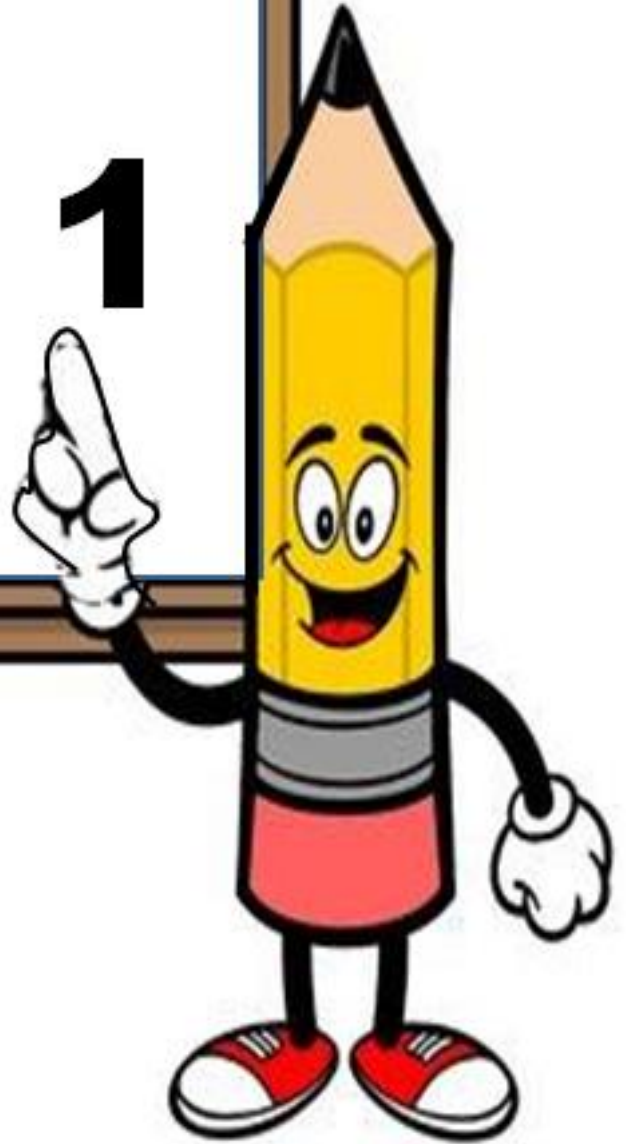

## Black History Exit Ticket

**Name 3 new facts you  
learned in today's reading:**

**Draw a picture to support:**

1. \_\_\_\_\_  
\_\_\_\_\_

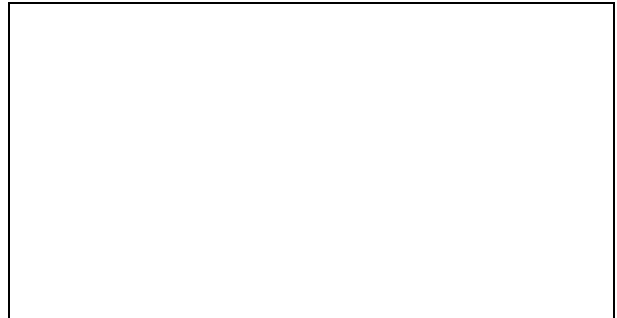

2. \_\_\_\_\_  
\_\_\_\_\_

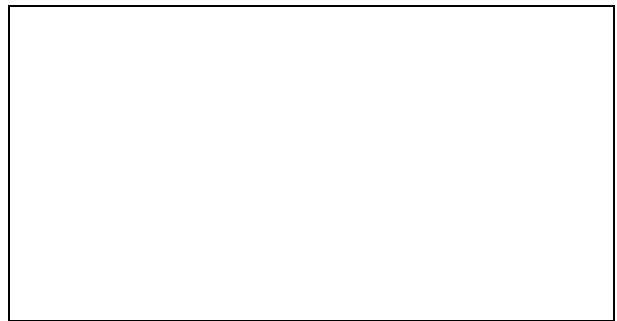

3. \_\_\_\_\_  
\_\_\_\_\_



Name \_\_\_\_\_ Week 23 Day 1 Date \_\_\_\_\_  
 BCCS-B RPI Siena Union  
 Homework

Find the words in the word search and circle them.

1. Look up two of the words you are not familiar with.

## Black History Month 2020

B	C	S	J	I	O	N	U	M	I	O	A	E	E
N	L	P	S	K	A	H	N	C	A	E	G	L	U
A	L	A	U	Q	E	R	A	K	E	E	O	T	K
A	T	C	N	S	E	R	S	O	M	T	E	T	A
N	K	E	C	A	H	L	A	B	E	I	N	U	T
E	L	A	G	A	H	S	S	E	Y	E	E	H	H
N	O	N	N	E	D	U	C	A	T	O	R	S	E
N	O	S	N	H	O	J	T	S	N	E	A	L	R
O	H	A	N	R	N	T	N	A	Y	R	B	U	I
L	C	B	B	I	N	P	H	T	A	M	A	A	N
G	S	O	J	G	A	O	B	E	T	H	U	N	E
M	I	M	I	H	G	N	I	K	L	M	U	R	A
L	L	A	B	T	E	K	S	A	B	Y	R	A	M
J	E	M	I	S	O	N	E	A	O	A	E	N	S

SPACE  
 KOBE  
 BRYANT  
 JOHNSON  
 EQUAL  
 JEMISON  
 MAE  
 SHUTTLE  
 EDUCATOR  
 MLKING  
 KATHERINE  
 RIGHTS  
 MATH  
 BETHUNE  
 MARY  
 SCHOOL  
 BASKETBALL  
 NASA



# Day # 2

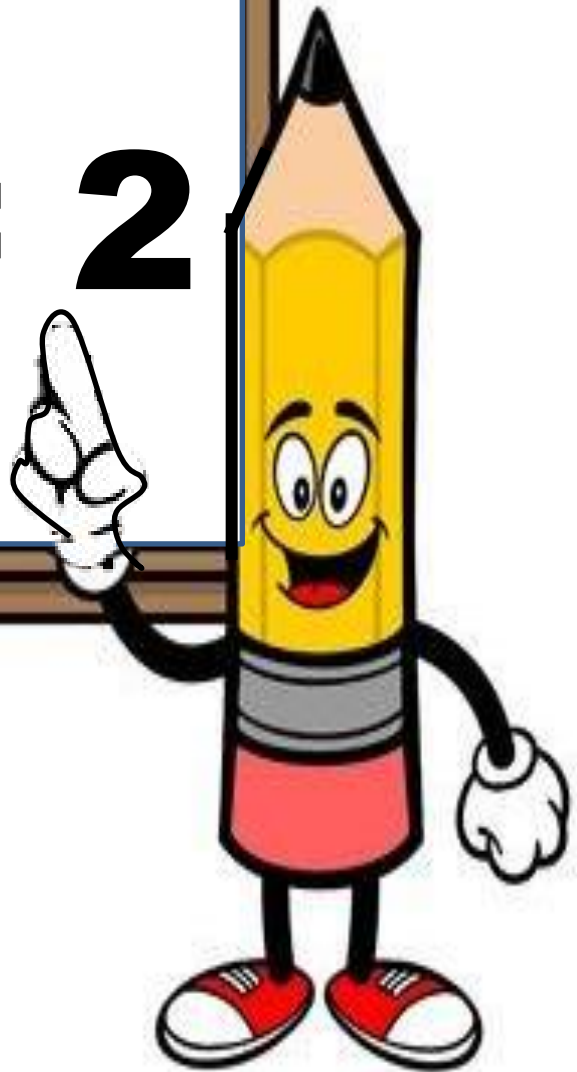



Name \_\_\_\_\_ Week 23 Day 2 Date \_\_\_\_\_  
BCCS-B RPI Siena Union

## Black History Exit Ticket

**Answer each question with a complete sentence.**

1. Who taught Malcolm about butterflies?

---

---

---

2. How did Malcom compare butterflies to people?

---

---

---

## Homework

**Read the passage about Mae Jemison. Answer the questions in complete sentences.**



Mae Carol Jemison was born in Decatur, Alabama, on October 17, 1956. She had three older siblings. Her mother taught English and Math, and her father worked keeping the building nice for a charity organization.

Mae knew she wanted to be a scientist of some kind since she was young. The TV series of Star Trek with black actress Nichelle Nichols inspired her to be an astronaut. She was the first black woman who went into space.

**Why did Mae Jemison want to be a scientist?**

---

---

**Who was part of Mae Jemison's "family" and support?**

---



**Day # 3**

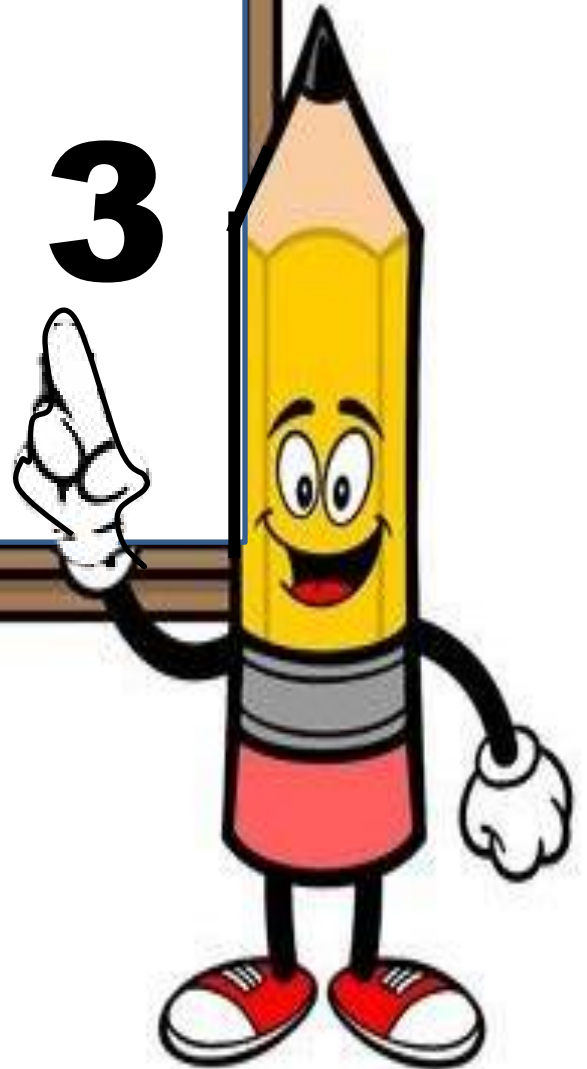

Name \_\_\_\_\_ Week 23 Day 3 Date \_\_\_\_\_  
BCCS-B RPI Siena Union

## Black History Exit Ticket

### Answer the following questions:

1. Who told the story about Rev. Dr. Martin Luther King, Jr. as a young man?

The story was told by \_\_\_\_\_.

2. Name two members of the young Martin's family:

1. \_\_\_\_\_

2. \_\_\_\_\_

Name \_\_\_\_\_ Week 23 Day 3 Date \_\_\_\_\_  
BCCS-B RPI Siena Union

Homework (page 1 of 2)

**Finish the picture by writing about what you would do to change our world:**

I can dream like Rev. Dr. King. My dream is...

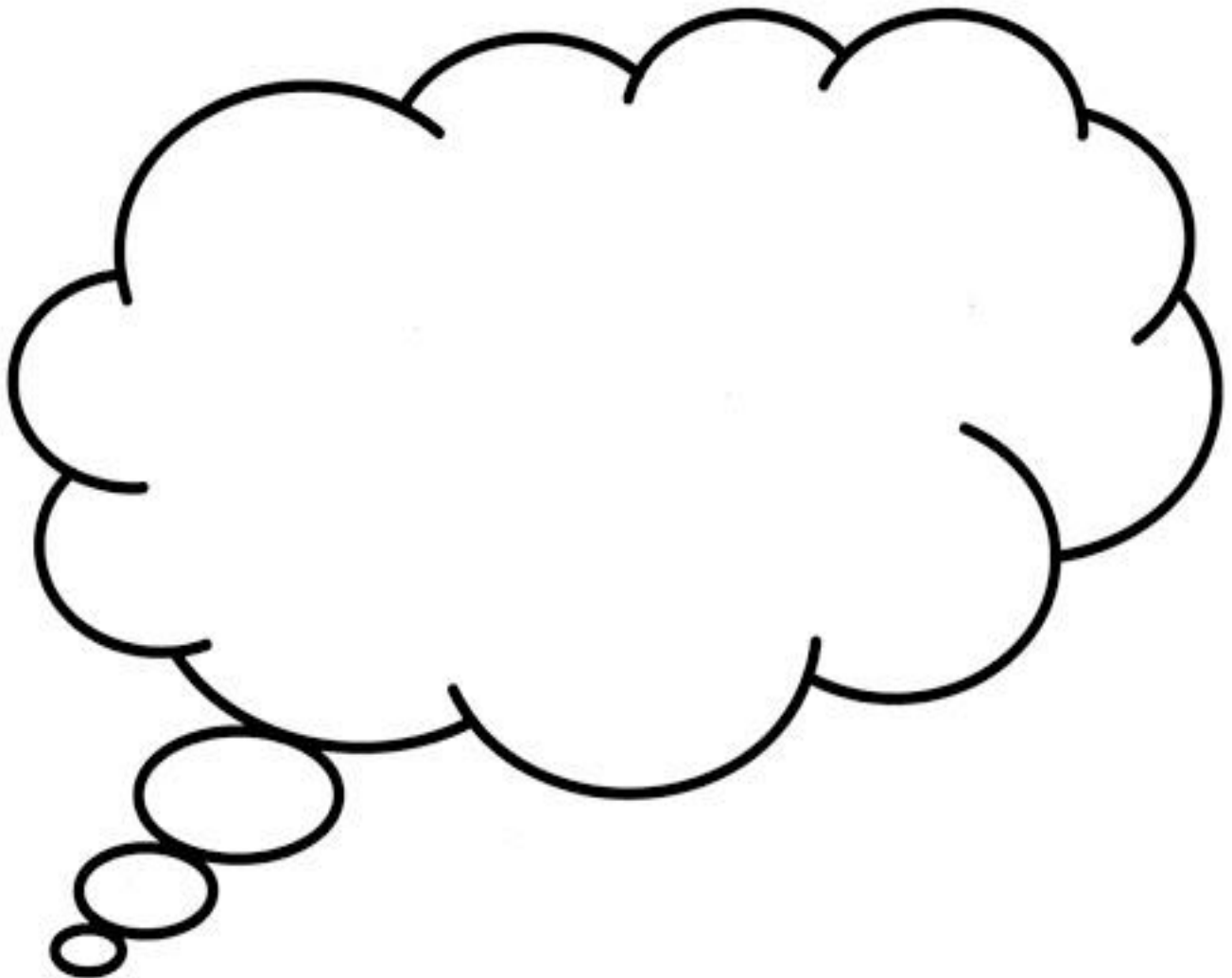

Color this quote from Rev. Dr. Martin Luther King, Jr.:





**Day # 4**

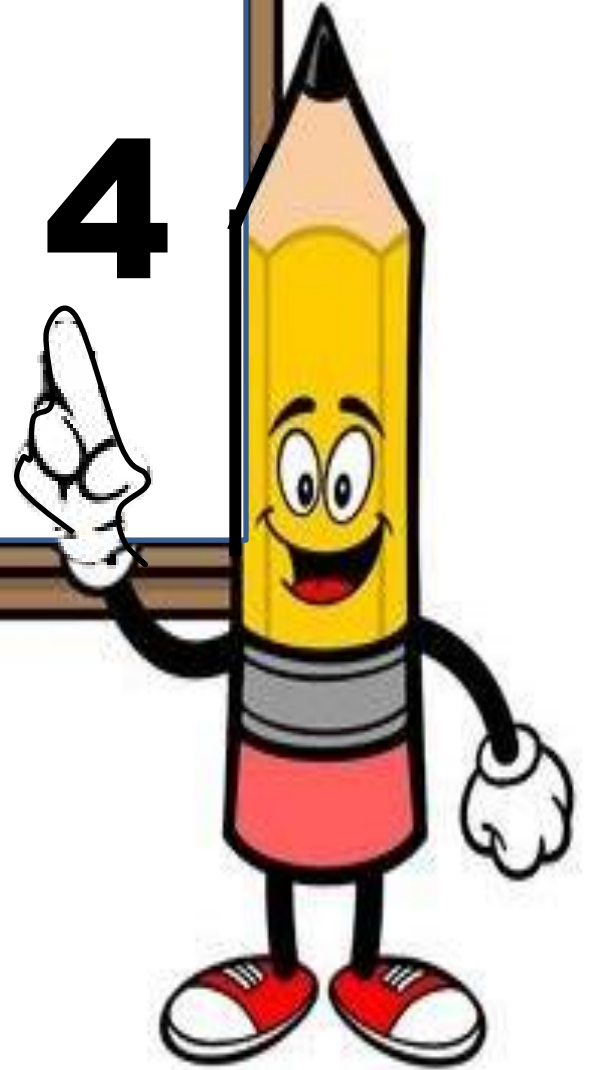

### Black History Exit Ticket

**Answer the question and add a picture to support it:**

What are two things that **you**, Malcolm X, Rev. Dr. Martin Luther King, Jr., and Jabari all have in common?

1. We all \_\_\_\_\_

\_\_\_\_\_

2. We also \_\_\_\_\_

\_\_\_\_\_

A way I can show this is:





Name \_\_\_\_\_ Week 23 Day 4 Date \_\_\_\_\_

BCCS-B

RPI

Siena

Union

## Homework

**Read the passage about Matthew Henson. Answer the questions in complete sentences.**



Matthew Henson's parents were attacked by the Ku Klux Klan and other mean groups led by white people who terrorized black people after the Civil War.

Because they looked for safety, the Henson family sold their farm and moved to Georgetown. Matthew had an older sister and two younger sisters. Matthew's mother died when Matthew was 7 years old.

Matthew was inspired by Frederick Douglass, who inspired many blacks to become activists. Frederick Douglass was a man who escaped slavery and was famous for speaking in public. He inspired Matthew to continue to follow his dreams.

**Who was part of Matthew Henson's "family" and support?**

---

---



**Day # 5**

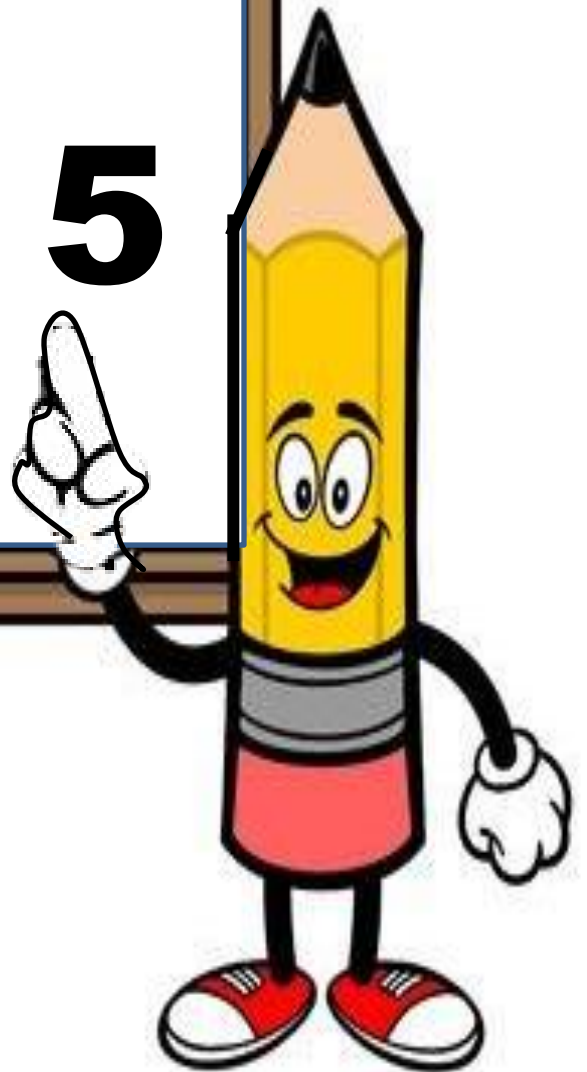

Read the passage below. Answer the questions.

## Henry Box Brown

Henry Box Brown was a slave. He wanted to escape to be free. So Henry mailed himself in a wooden box. He went to Pennsylvania. Twenty-seven days later, he was there!



1. What was Henry Brown before he escaped?

-----

2. How did he escape?

-----

3. How long did it take Henry to get to Pennsylvania?

-----

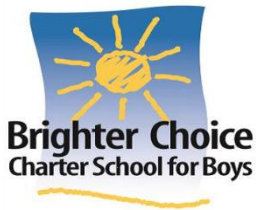

Name \_\_\_\_\_



# 1<sup>st</sup> Grade ELA Remote Learning Packet

## Week 24



Dear Educator,

My signature is proof that I have reviewed my scholar's work and supported him to the best of my ability to complete all assignments.

\_\_\_\_\_  
(Parent Signature)

\_\_\_\_\_  
(Date)

Parents please note that all academic packets are also available on our website at [www.brighterchoice.org](http://www.brighterchoice.org) under the heading "Remote Learning." All academic packet assignments are mandatory and must be completed by all scholars.



**Day # 1**

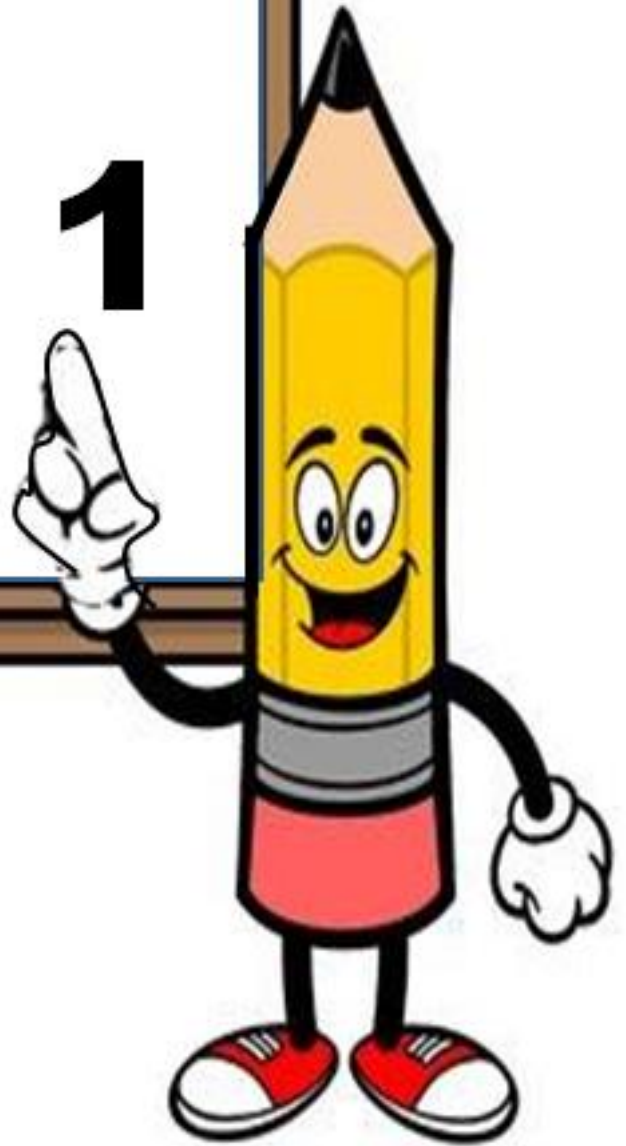

Name: \_\_\_\_\_ Week 24 Day 1 Date: \_\_\_\_\_  
BCCS-B RPI SIENA UNION

### Astronomy (D6.W3.L1) Classwork

Directions: Circle the things scientist and astronauts both need to get to space.



Name: \_\_\_\_\_ Week 24 Day 1 Date: \_\_\_\_\_  
BCCS-B RPI SIENA UNION

### Astronomy (D6.W3.L1) Exit Ticket

**Directions:** What are three things scientist need to explore the moon?

- 1. \_\_\_\_\_
- 2. \_\_\_\_\_
- 3. \_\_\_\_\_

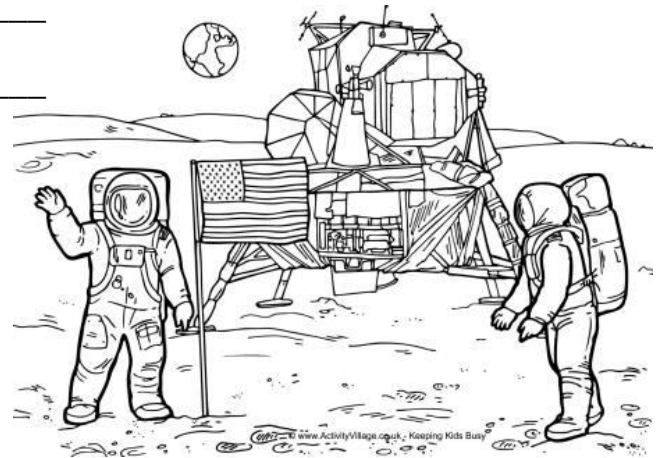

4. Who was the first astronaut to step on the moon?

**Michael Collins**

**Neil Armstrong**

**Buzz Aldrin**

5. What did the astronauts bring back from the moon?

---

Name: \_\_\_\_\_ Week 24 Day 1 Date: \_\_\_\_\_  
BCCS-B RPI SIENA UNION

### Homework

Directions: Write BR or TR for each picture.

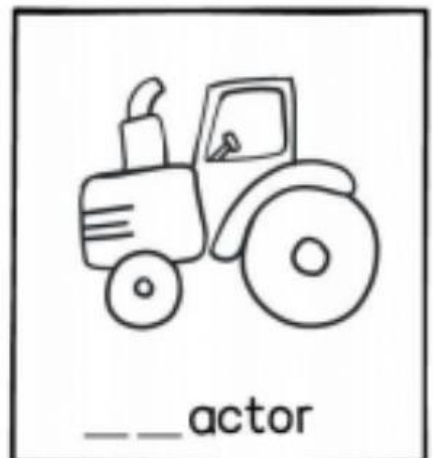
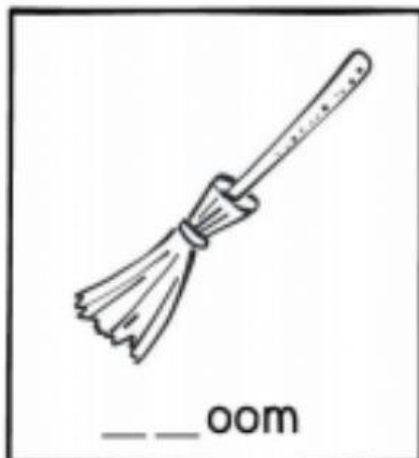
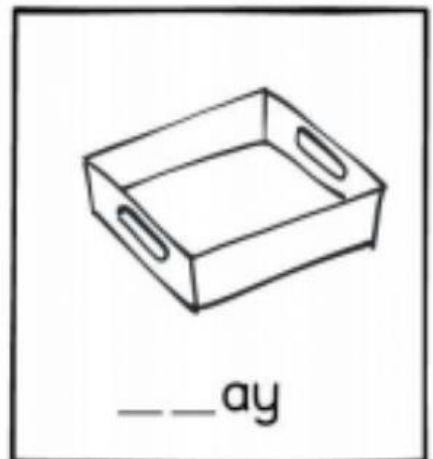
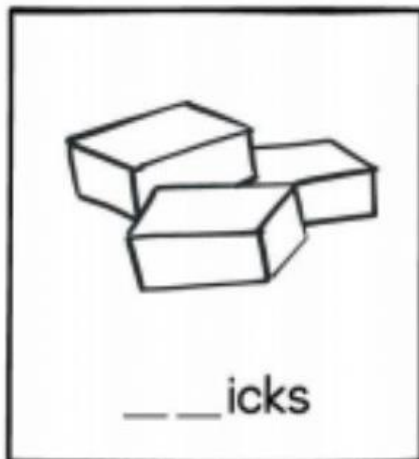
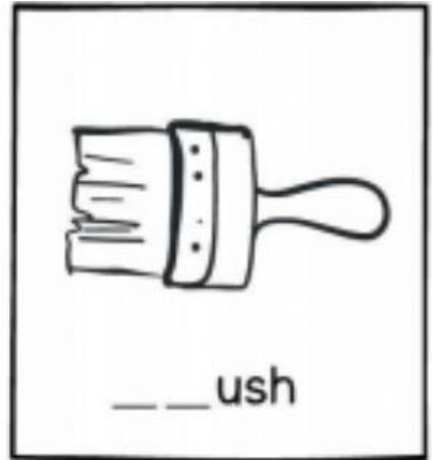
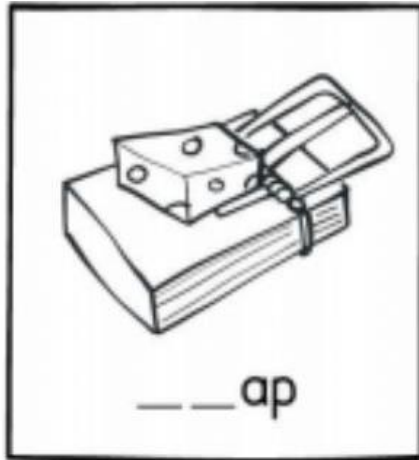
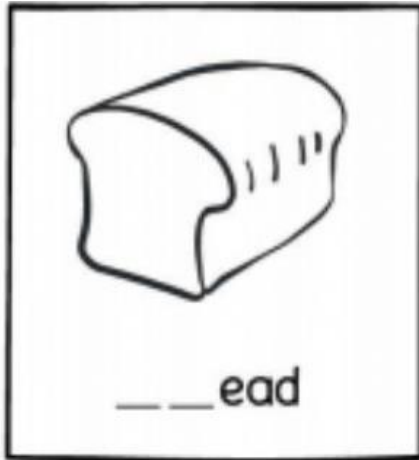





# Day # 2

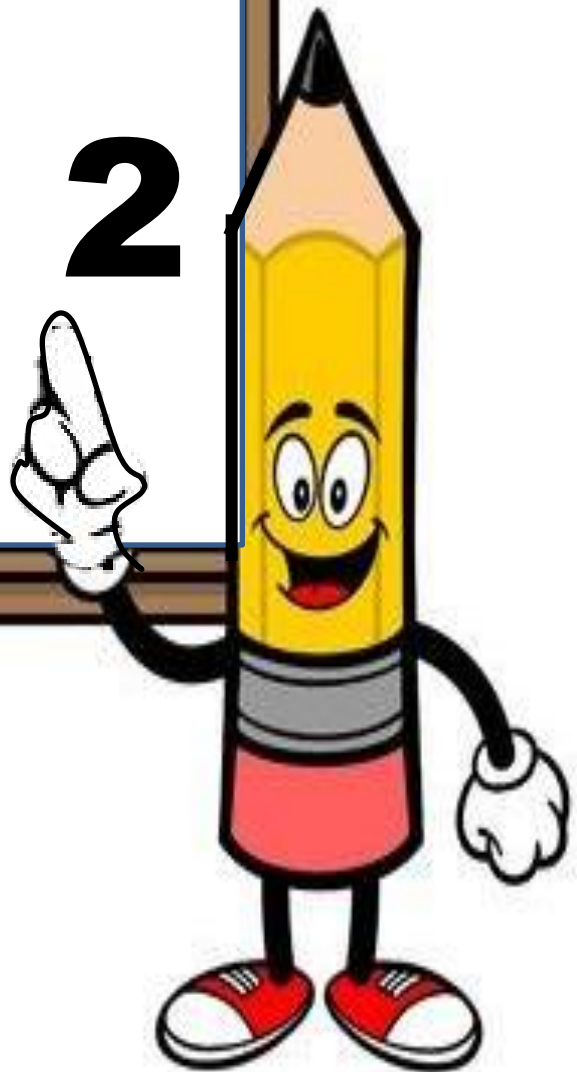





**Astronomy (D6.W3.L2) Classwork**

**Directions: Give facts about the inner planets.**

# The Inner Solar System

- the first four planets
- closest to the sun
- warmer
- made of rocks

Research and explain each.

<p><b>Mercury</b> </p> <hr/> <hr/> <hr/> <hr/> <hr/> <hr/>	<p><b>Venus</b> </p> <hr/> <hr/> <hr/> <hr/> <hr/> <hr/>
<p><b>Earth</b> </p> <hr/> <hr/> <hr/> <hr/> <hr/> <hr/>	<p><b>Mars</b> </p> <hr/> <hr/> <hr/> <hr/> <hr/> <hr/>

Name: \_\_\_\_\_ Week 24 Day 2 Date: \_\_\_\_\_  
BCCS-B RPI SIENA UNION

### Astronomy (D6.W3.L2) Exit Ticket

**Directions:** Label the first 4 planets from the sun.

Earth	Mars	Venus	Mercury
-------	------	-------	---------

Mercury

Venus

Earth

Mars

Name: \_\_\_\_\_ Week 24 Day 2 Date: \_\_\_\_\_





BCCS-B

RPI SIENA

UNION

### Homework

Directions: Write the two letters that the picture begins with.

 _____ant	 _____lock	 _____im
 _____agon	 _____ate	 _____ake
 _____ar	 _____esent	 _____oon



# Day # 3

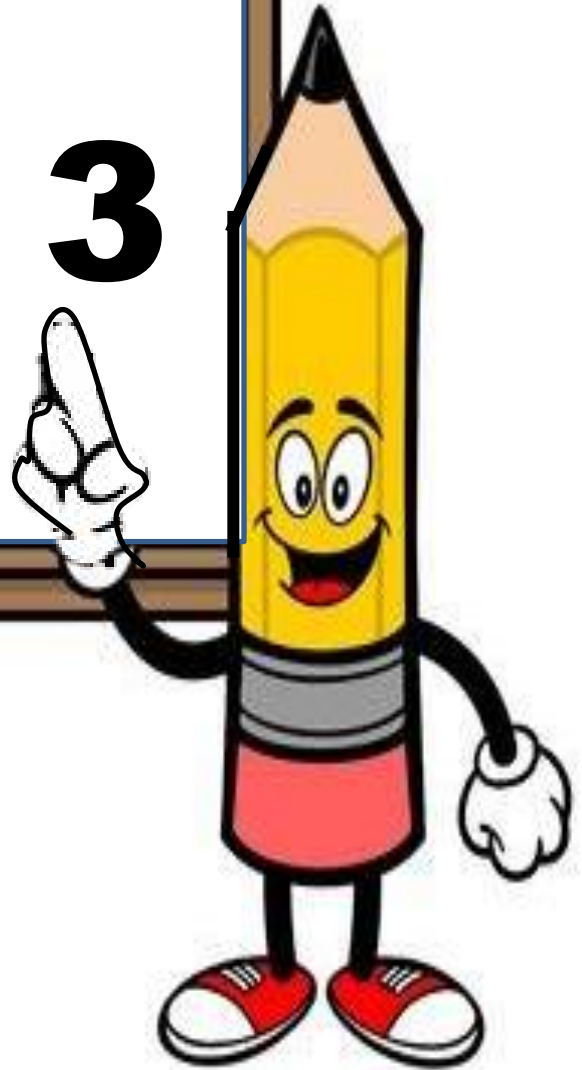

Name: \_\_\_\_\_ Week 24 Day 3 Date: \_\_\_\_\_  
BCCS-B RPI SIENA UNION

### Astronomy (D6.W3.L3) Classwork

**Directions:** Give facts about the first two outer planets. Cross out the other planets.

JUPITER



---

---

---

---

---

SATURN



---

---

---

---

---

URANUS



---

---

---

---

---

NEPTUNE



---

---

---

---

---

Name: \_\_\_\_\_ Week 24 Day 3 Date: \_\_\_\_\_  
BCCS-B RPI SIENA UNION

**Astronomy (D6.W3.L3) Exit Ticket**

**Directions: Answers the questions.**

**1. Why are outer planets called the outer planets?**

---

---

---

---

---

---

---

---

**2. You can stand on an outer planet.**

True

False

**3. \_\_\_\_\_ is the biggest planet?**

Earth

Jupiter

**4. \_\_\_\_\_ has rings.**

Saturn

Mars

Name: \_\_\_\_\_ Week 24 Day 3 Date: \_\_\_\_\_  
BCCS-B RPI SIENA UNION

### Homework

Directions: Write the correct blends at the beginning of the word.

dr	fr	tr	br	cr
----	----	----	----	----



\_\_\_\_\_og



\_\_\_\_\_uck



\_\_\_\_\_um



\_\_\_\_\_ush

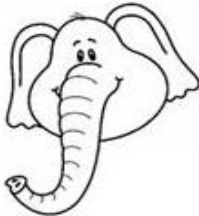

\_\_\_\_\_unk



\_\_\_\_\_op



\_\_\_\_\_uit



\_\_\_\_\_ink



\_\_\_\_\_ab



\_\_\_\_\_ee





# Day # 4

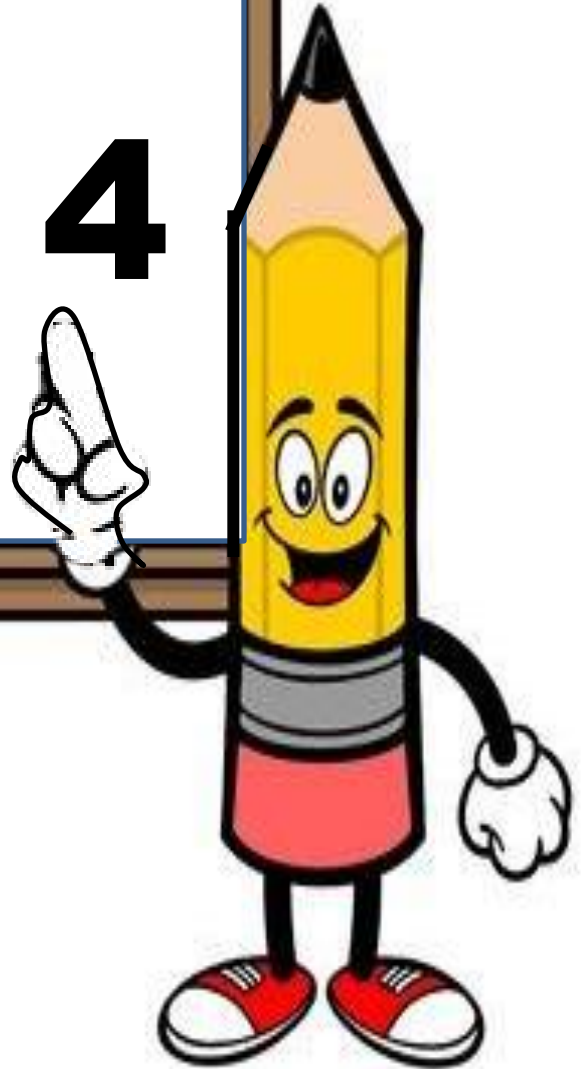

Name: \_\_\_\_\_ Week 24 Day 4 Date: \_\_\_\_\_  
BCCS-B RPI SIENA UNION

### Astronomy (D6.W3.L4) Classwork

**Directions: Complete the questions about Neptune.**

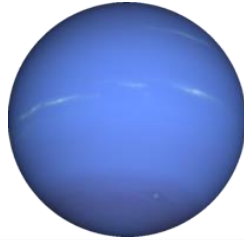

Neptune is the \_\_\_\_\_ planet in line from the Sun.

Neptune has \_\_\_\_\_ moons.

Neptune has \_\_\_\_\_ rings.

Is Neptune a terrestrial or gaseous planet? \_\_\_\_\_

Have any spacecraft ever visited Neptune? \_\_\_\_\_

If so, how many? \_\_\_\_\_ Tell about one: \_\_\_\_\_

\_\_\_\_\_

What gases primarily make up Neptune's atmosphere?

\_\_\_\_\_

How long is 1 day on the planet Neptune? \_\_\_\_\_ Earth hours.

How long is 1 year on the planet Neptune? \_\_\_\_\_ Earth years.

Who are Neptune's moons named after? \_\_\_\_\_

\_\_\_\_\_

Do you think humans will ever walk on Neptune? \_\_\_\_\_

Name: \_\_\_\_\_ Week 24 Day 4 Date: \_\_\_\_\_  
BCCS-B RPI SIENA UNION

### Astronomy (D6.W3.L4) Classwork

Directions: Complete the questions about Uranus.

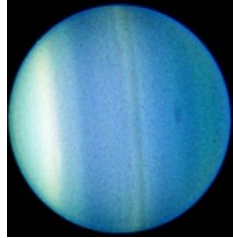

Uranus is the \_\_\_\_\_ planet in line from the Sun.

Uranus has \_\_\_\_\_ moons.

Uranus has \_\_\_\_\_ rings.

Is Uranus a terrestrial or gaseous planet? \_\_\_\_\_

Have any spacecraft ever visited Uranus? \_\_\_\_\_

If so, how many? \_\_\_\_\_ Tell about one: \_\_\_\_\_

What gases primarily make up Uranus's atmosphere?  
\_\_\_\_\_

How long is one day on the planet Uranus? \_\_\_\_\_ Earth hours.

How long is 1 year on the planet Uranus? \_\_\_\_\_ Earth years.

Who are Uranus's moons named after? \_\_\_\_\_

Do you think humans will ever walk on Uranus? \_\_\_\_\_

Name: \_\_\_\_\_ Week 24 Day 4 Date: \_\_\_\_\_  
BCCS-B RPI SIENA UNION

### Astronomy (D6.W3.L4) Exit Ticket

**Directions: Read the questions and answer.**

**1. What are outer planets made of?**

---

---

---

**2. Neptune is the 2<sup>nd</sup> planet in the solar system.**

- True
- False

**3. \_\_\_\_\_ is the farthest planet from the sun?**

- Neptune
- Venus













**4. \_\_\_\_\_ has rings.**

- Saturn
- Uranus

Name: \_\_\_\_\_ Week 24 Day 4 Date: \_\_\_\_\_  
 BCCS-B RPI SIENA UNION

**Homework**

**Directions:** Circle the correct blend that matches the picture.

 <b>st</b> <b>sm</b>	 <b>sp</b> <b>sl</b>	 <b>sl</b> <b>sw</b>
 <b>sn</b> <b>st</b>	 <b>sm</b> <b>sp</b>	 <b>st</b> <b>sc</b>
 <b>sw</b> <b>sp</b>	 <b>sk</b> <b>st</b>	 <b>sp</b> <b>sw</b>
 <b>sc</b> <b>st</b>	 <b>sp</b> <b>sn</b>	 <b>sl</b> <b>sm</b>



# Day # 5

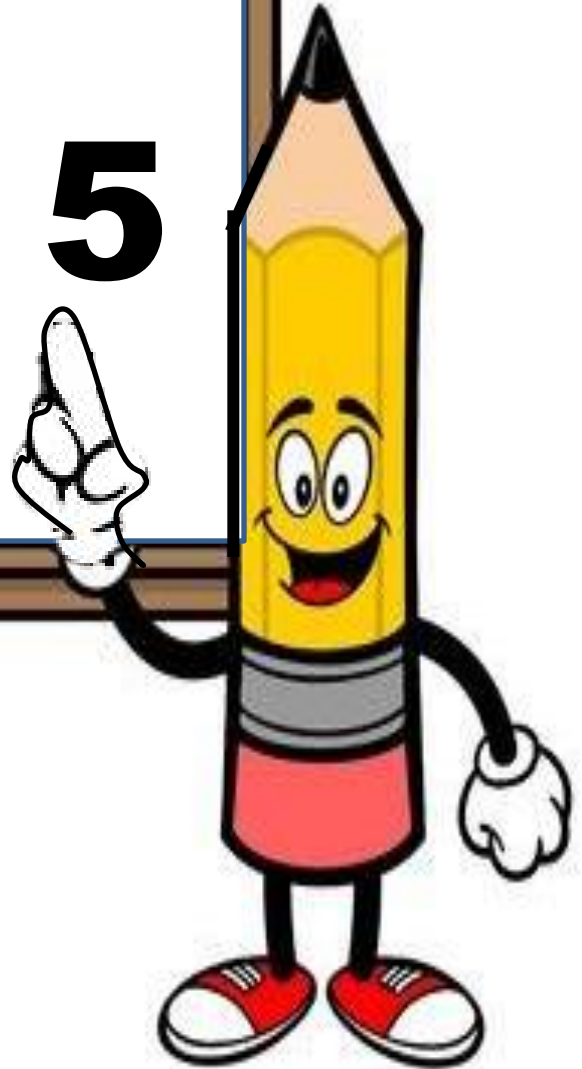

Name: \_\_\_\_\_ Week 24 Day 5 Date: \_\_\_\_\_  
BCCS-B RPI SIENA UNION

### Homework

Directions: Write a response to the prompt below using 5 complete sentences.

When it's cold outside I like to...











Handwriting practice lines consisting of 15 horizontal lines with dashed midlines, arranged in two groups of five lines each.

Name: \_\_\_\_\_ Week 24 Day 5 Date: \_\_\_\_\_  
BCCS-B RPI SIENA UNION

### Homework

Directions: Circle the beginning blend and write it on the line.

 _____ _____ own _____ cr br gr	 _____ _____ ice _____ fr tr pr	 _____ _____ um _____ dr fr br
 _____ _____ ee _____ cr pr tr	 _____ _____ og _____ fr pr gr	 _____ _____ ead _____ br fr pr
 _____ _____ ab _____ pr gr cr	 _____ _____ ape _____ dr br gr	