



Name _____

3rd Grade Modified Math Remote Learning Packet

Week 32



Dear Educator,

My signature is proof that I have reviewed my scholar's work and supported him to the best of my ability to complete all assignments.

(Parent Signature)

(Date)

Parents please note that all academic packets are also available on our website at www.brighterchoice.org under the heading "Remote Learning." All academic packet assignments are mandatory and must be completed by all scholars.



Day # 1

NYS Math Exam Practice

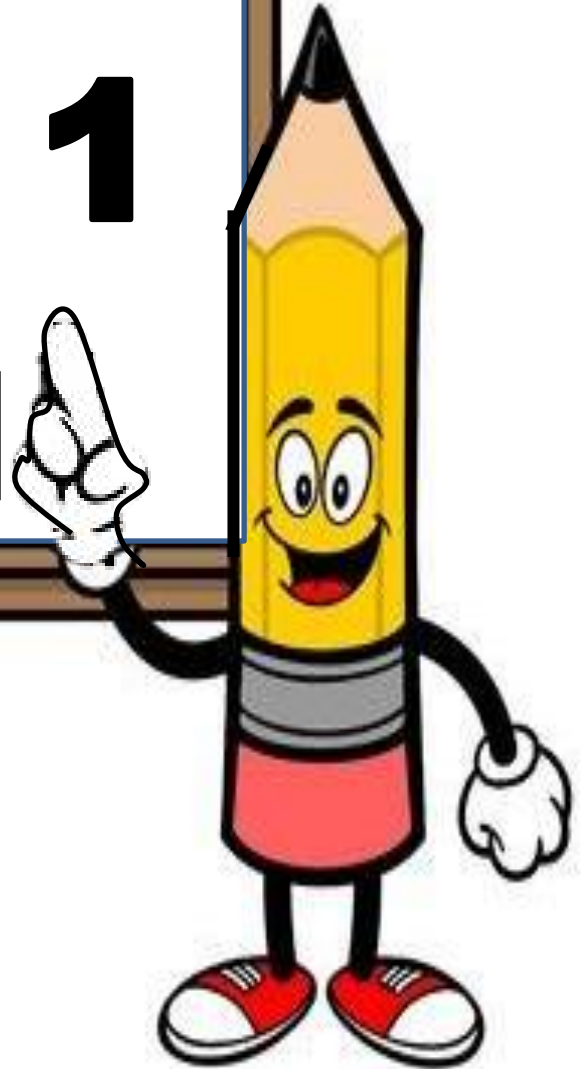

LEQ: How can I review fractions to be successful on the NYS math exam?

Objective: I can use a set of rules, take great notes, and ask/answer questions to review fractions and be successful on the NYS math exam.

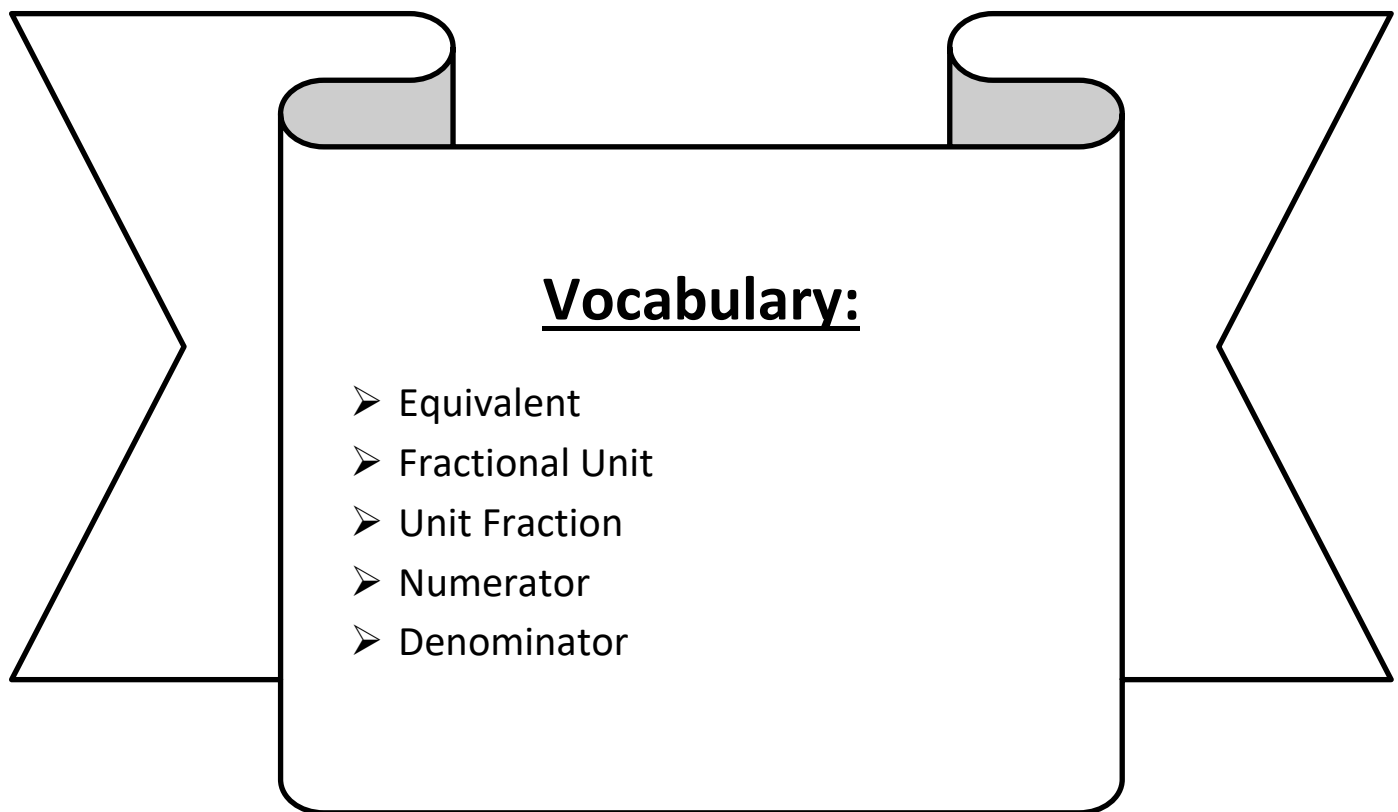

What is a **Fraction**?

Part of a whole

A number that expresses equal parts of a whole object or set of objects.

$\frac{2}{3}$ $\frac{1}{2}$ $\frac{3}{4}$ $\frac{4}{7}$

part
whole

Parts of a fraction:

$\frac{1}{2}$

← **numerator** = how many fraction pieces you have

← **denominator** = how many fraction pieces your whole is broken into
*d = down

↗ **fraction bar**
*represents division

KEY WORDS: halves, thirds, fourths, fifths, sixths, sevenths, eighths, etc.

Different Ways to Represent a Fraction

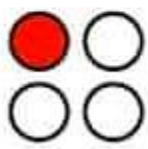
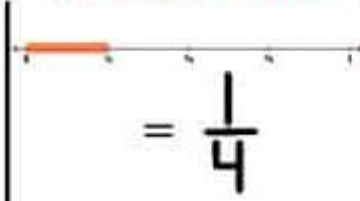
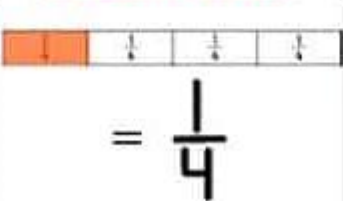
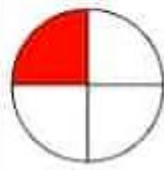
Part of a Group	Number Line	Fraction Bar	Fraction Circle
 = $\frac{1}{4}$	 = $\frac{1}{4}$	 = $\frac{1}{4}$	 = $\frac{1}{4}$

Name: _____

Week 32 Day 1 Date: _____

BCCS-B

Harvard

Yale

Princeton

1. The distance between Liam's home and his school is exactly 1 mile, as shown on the number line below.

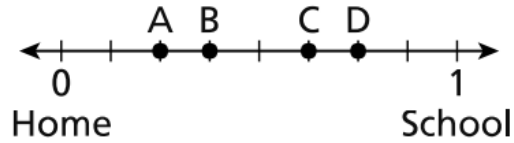

Liam buys a snack at a store that is $\frac{3}{8}$ mile from his home. What point on the number line shows the location of the store?

- A point A
 - B point B
 - C point C
 - D point D
2. Kay and Juanita each have a garden of the same size and shape.
- Kay grows flowers in $\frac{1}{6}$ of her garden.
 - Juanita grows flowers in $\frac{1}{3}$ of her garden.

Which statement shows a correct comparison of the sections of flowers grown in Kay's garden and Juanita's garden?

- A $\frac{1}{6} > \frac{1}{3}$
- B $\frac{1}{6} < \frac{1}{3}$
- C $\frac{1}{3} = \frac{1}{6}$
- D $\frac{1}{3} + \frac{1}{6}$

3. Which number line shows the fraction $\frac{1}{3}$ plotted correctly?

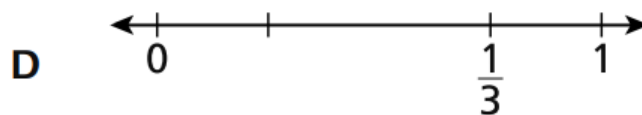
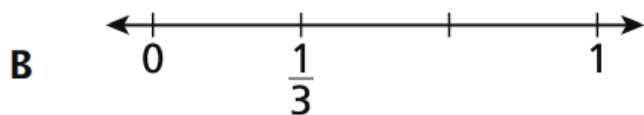
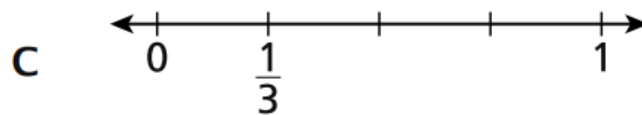
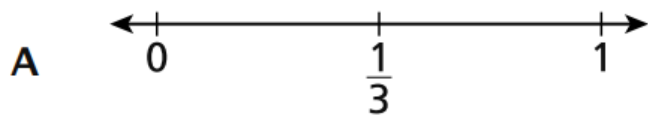

4. Theo divided a garden equally into 6 parts. He planted seeds in 5 of the parts. In what fraction of the garden did Theo plant seeds?

A $\frac{1}{6}$

B $\frac{1}{5}$

C $\frac{5}{6}$

D $\frac{6}{5}$

5. Jaime has a small container that holds exactly $\frac{1}{4}$ cup of dog food. How many times should Jaime fill the container and pour it into the dog's bowl to make sure the dog gets exactly $\frac{1}{2}$ cup of food?

A $\frac{1}{4}$

B $\frac{1}{2}$

C 2

D 4

6. Gianna cuts a ribbon into equal pieces as shown below.



She uses 4 pieces of the ribbon for a project. What fraction of the ribbon does Gianna use for the project?

Explain how you found your answer.

Gianna uses _____ of the ribbon for her project.

7. The Diaz family used a spinner to play a game. The spinner was in the shape of a circle. Each section of the spinner was $\frac{1}{4}$ of the whole circle. Which picture shows a spinner that the Diaz family used?

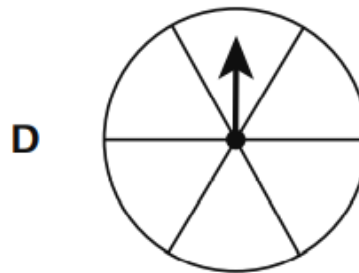
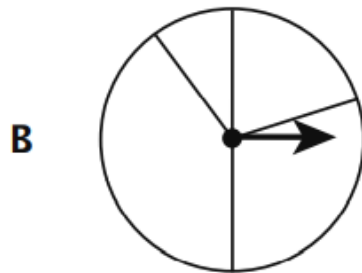
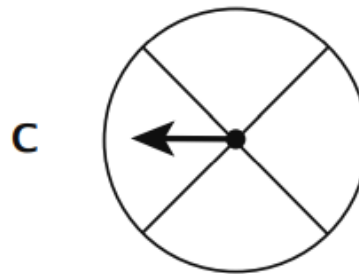
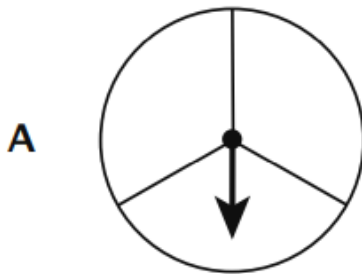

8. Which fraction is equivalent to 4?

A $\frac{1}{4}$

B $\frac{8}{4}$

C $\frac{4}{4}$

D $\frac{4}{1}$

9. Two teachers each buy pizzas for a party. All of the pizzas are the same size.

- Teacher A's pizzas were cut into 6 equal slices.
- Teacher B's pizzas were cut into 8 equal slices.

Which teacher's pizzas were cut into larger slices? Use what you know about fractions to explain your answer.

Answer

Teacher _____'s pizza was cut into larger slices.

10. Which two fractions should be plotted at the same location on a number line?

A $\frac{3}{4}$ and $\frac{4}{8}$

B $\frac{1}{4}$ and $\frac{2}{8}$

C $\frac{2}{4}$ and $\frac{4}{6}$

D $\frac{1}{2}$ and $\frac{2}{6}$

11. The shape below is shaded to represent a fraction.

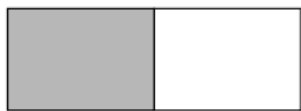

Which shape is shaded to represent a fraction equivalent to the shape shown above?

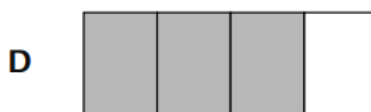
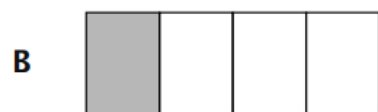
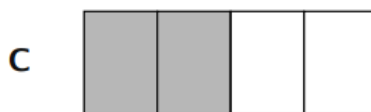

12. Which fraction is equal to $\frac{2}{8}$?

A $\frac{8}{2}$

B $\frac{1}{2}$

C $\frac{2}{4}$

D $\frac{1}{4}$

13. Two families buy large sandwiches of the same size. Family A shares one sandwich equally among 4 people, as represented in the picture below.



Family B shares one sandwich equally between 2 people.

Will a person from Family A get the same amount or a different amount of a sandwich as a person from Family B? Be sure to include what you know about fractions or parts of a whole in your answer.

Explain your answer.

A person from Family A will get _____ amount of a sandwich as a person from Family B. I know this because _____

14. Four different recipes were used by students to bake cookies for a bake sale. The number line below shows the fraction of a cup of milk needed in each recipe.

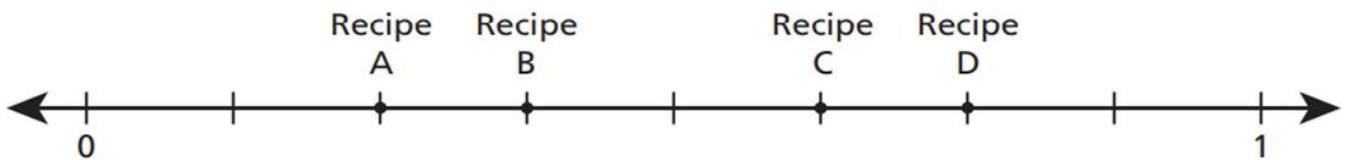

Which recipe needs $\frac{3}{8}$ cup of milk?

- A Recipe A
- B Recipe B
- C Recipe C
- D Recipe D

15. The fraction strip shown below is shaded to represent a fraction.



Total # Boxes

Which fraction strip is shaded to represent a fraction equal to the fraction strip shown above?



16. Which fraction comparison is **not** correct?

A $\frac{1}{3} < \frac{2}{3}$

B $\frac{3}{4} < \frac{1}{4}$

C $\frac{2}{3} > \frac{2}{8}$

D $\frac{5}{6} > \frac{5}{8}$

Name: _____

Week 32 Day 1 Date: _____

BCCS-B

Harvard

Yale

Princeton

Homework (2 PAGES):

1. The figure below is divided into equal-sized parts.

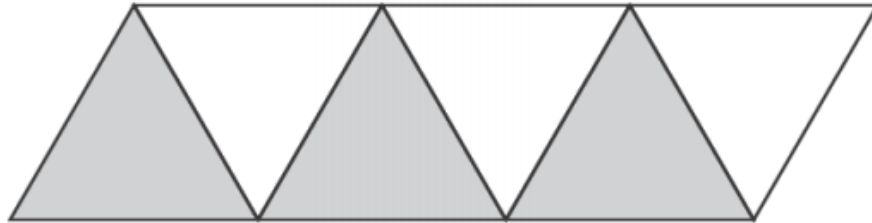

Which fraction is represented by the shaded parts of the figure?

- A $\frac{1}{3}$
- B $\frac{3}{3}$
- C $\frac{3}{6}$
- D $\frac{6}{3}$

2. Which fraction does point P represent on the number line below?

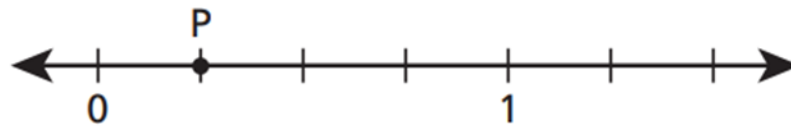

- A $\frac{1}{6}$
- B $\frac{2}{6}$
- C $\frac{1}{4}$
- D $\frac{2}{4}$

3. Which of these is shaded to represent $\frac{2}{3}$?

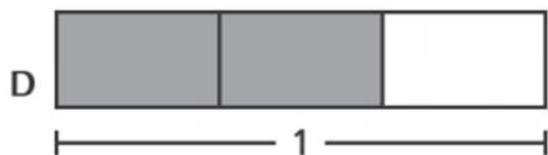
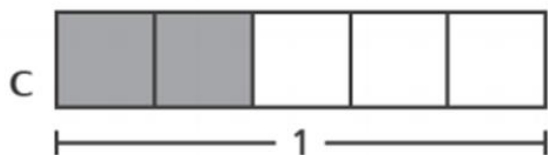

4. Erin walked 1 mile from her house to the library. Along the way, she passed several places shown on the number line below.



Which place is $\frac{4}{8}$ mile from Erin's house?

- A the fire station
- B the park
- C the school
- D the market



Day # 2

NYS Math Exam Practice

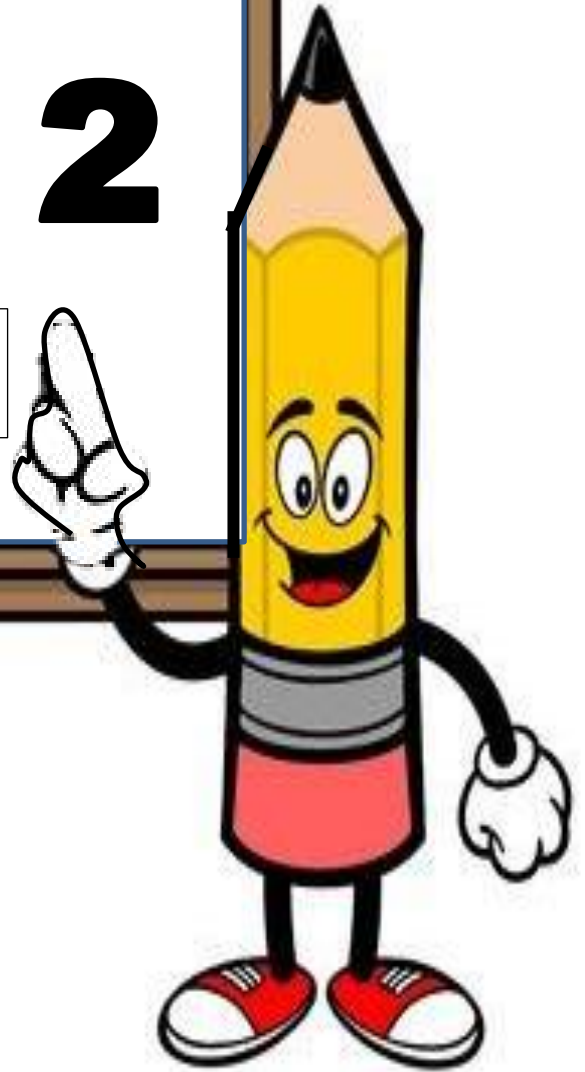

LEQ: How can I review division to be successful on the NYS math exam?

Objective: I can use a set of rules, take great notes, and ask/answer questions to review division and be successful on the NYS math exam.

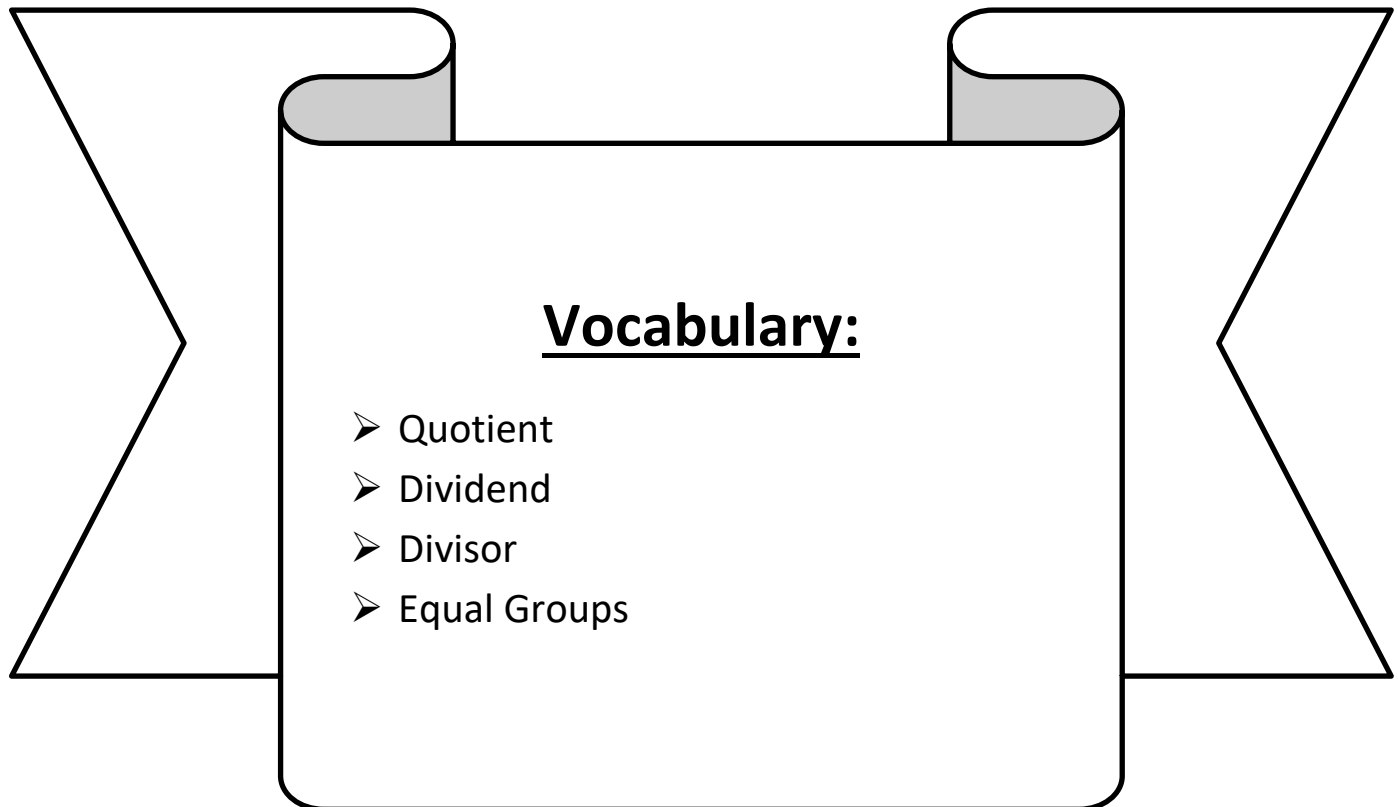

Division Concepts & Strategies

How Many in Each Group?

Bob, Sue and Mike picked 12 apples to share equally. How many will each get?

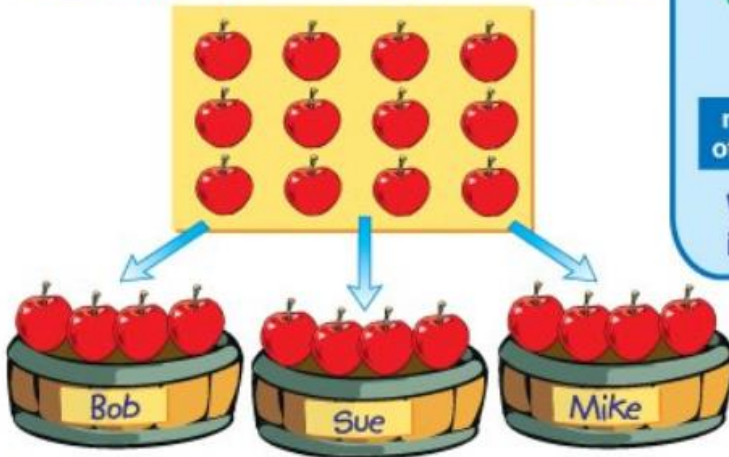

Division Sentence

dividend	divisor	quotient
12	3	= 4
↑	↑	↑
number of apples	number of baskets	number of apples in each basket

We use division to find the number in each group.

- 3 equal groups
- 4 in each group

How Many Groups?

We use repeated subtraction to find out how many groups of 4 are in 12.

1. $12 - 4 = 8$



2. $8 - 4 = 4$



3. $4 - 4 = 0$



We subtracted 4 three times. Therefore, there are 3 groups of 4 in 12.

Using Multiplication to Divide

factor	factor	product
3	x 4	= 12
number of equal groups	group size	total number

12 red apples are arranged in a 3x4 grid.

dividend	divisor	quotient
12	÷ 3	= 4
total number	number of groups	number in each group

12 red apples are arranged in three rows of four.

Using a Number Line

$$12 \div 3 = 4$$

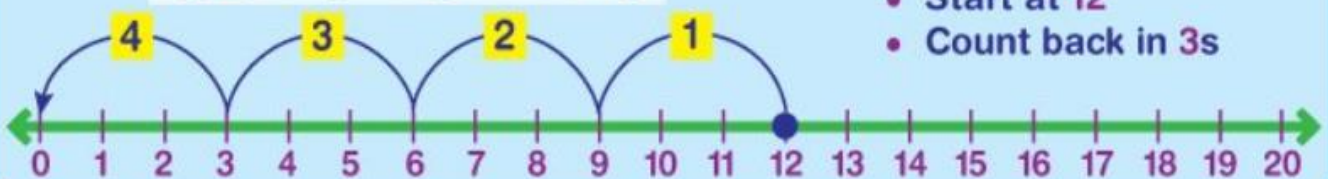

- Count back to divide
- Start at 12
- Count back in 3s

Name: _____

Week 32 Day 2 Date: _____

BCCS-B

Harvard

Yale

Princeton

1. Alexis read **63 pages** of a book in seven days. She read an equal number of pages each day. The equation below can be used to find the total number of pages she read each day.

$$63 \div 7 = \underline{\quad? \quad}$$

What is the total number of pages Alexis read each day?

- A** 8
- B** 9
- C** 56
- D** 70
2. Alex sorted **20 toy cars** into 4 groups with the same number of cars in each group. Which expression represents the number of toy cars in each group?
- A** 20×4
- B** $20 + 4$
- C** $20 \div 4$
- D** $20 - 4$
3. A certain dance class has **42 dancers**. The teacher wants to place the class into six equal groups. Which number sentence could be used to find the number of dancers that will be in each group?

A $6 \times \underline{\quad? \quad} = 42$

B $6 \div \underline{\quad? \quad} = 42$

C $42 + 6 = \underline{\quad? \quad}$

D $42 - 6 = \underline{\quad? \quad}$

4. Mr. Bachu bought 24 pounds of potting soil. Which sentence could describe the potting soil Mr. Bachu bought?
- A** He bought 6 bags that weigh 4 pounds each.
 - B** He bought 5 bags that weigh 4 pounds each.
 - C** He bought 4 bags that weigh 20 pounds each.
 - D** He bought 10 bags that weigh 14 pounds each.

5. The school store sells pencils in packages of 4. Zoe bought enough packages to have 28 pencils. The equation below can be used to determine the number of packages Zoe bought.

$$4 \times \underline{\quad?} = 28$$

What is the total number of packages that Zoe bought?

- A** 6
 - B** 7
 - C** 24
 - D** 32
6. Rick has 15 muffins. He will give each of his three children one muffin each day. The equation below can be used to find the total number of days he can give the muffins to his children before they are gone.

$$15 \div \underline{\quad?} = 3$$

What is the total number of days Rick can give the muffins to his children?

- A** 4
- B** 5
- C** 12
- D** 18

7. Which number sentence could also be used to find the missing number in the equation $10 \times \underline{\quad ? \quad} = 60$?

A $60 \times 10 = \underline{\quad ? \quad}$

B $60 - 10 = \underline{\quad ? \quad}$

C $60 + 10 = \underline{\quad ? \quad}$

D $60 \div 10 = \underline{\quad ? \quad}$

8. What number makes the equation below true?

$$81 \div \underline{\quad} = 9$$

A 8

B 9

C 72

D 90

11. The first number in a number pattern is 28. The pattern rule is to add 14 to get the next number in the pattern. If the pattern continues, which statement is true?

- A All the numbers in the pattern can be divided equally by 10.
- B All the numbers in the pattern can be divided equally by 4.
- C All the numbers in the pattern can be divided equally by 8.
- D All the numbers in the pattern can be divided equally by 7.

12. What number makes the equation below true?

$$35 \div ? = 7$$

- A 5
- B 6
- C 7
- D 8

13. Tayshawn sorts 56 marbles into equal groups with no marbles left over. Which statement could be true of the groups of marbles Tayshawn sorts?

- A There are 6 groups of marbles with 8 marbles in each group.
- B There are 7 groups of marbles with 7 marbles in each group.
- C There are 8 groups of marbles with 7 marbles in each group.
- D There are 9 groups of marbles with 6 marbles in each group.

14. Anya placed 16 cups in rows on a table. There are 8 cups in each row. Which equation could be used to represent this situation?

A $16 \times 8 = \square$

B $8 + 16 = \square$

C $\square \div 8 = 16$

D $\square \times 8 = 16$

15. Which pair of equations is true when the number 8 is placed in the blanks?

A $4 \times \underline{\quad} = 32$
 $32 \div \underline{\quad} = 4$

B $5 \times \underline{\quad} = 40$
 $\underline{\quad} \div 40 = 5$

C $6 \times 48 = \underline{\quad}$
 $48 \div \underline{\quad} = 6$

D $7 \times \underline{\quad} = 63$
 $63 \div \underline{\quad} = 7$

16. A total of 30 players will play basketball at a park. There will be exactly 5 players on each team. Which statement correctly explains how to find the number of teams needed?

- A Add 5 to 30 to find 35 teams.
- B Divide 30 by 5 to find 6 teams.
- C Multiply 30 and 5 to find 150 teams.
- D Subtract 5 from 30 to find 25 teams.

17. What number multiplied by 4 equals 36?

- A 6
- B 7
- C 8
- D 9

18. Ms. Perez drove a total of 40 miles in 5 days. She drove the same number of miles each day. How many miles did Ms. Perez drive each day?

- A 5
- B 7
- C 8
- D 9

19. A band has 36 members. They are arranged into 6 equal rows. How many band members are in each row?

Show your work.

Row 1	
Row 2	
Row 3	
Row 4	
Row 5	
Row 6	

Can the same 36 band members be placed into exactly 7 equal rows? Why or why not?

Explain your answer.

20. What number makes the equation true?

$$4 = \underline{\quad ? \quad} \div 7$$

A 11

B 21

Name: **C** 28

BCCS-E **D** 32

Day 2 Date: _____

Yale

Princeton

Homework:

1. What number makes both equations true?

$$6 \times \underline{\quad ? \quad} = 48$$

$$48 \div 6 = \underline{\quad ? \quad}$$

- A 7
- B 8
- C 42
- D 54
2. Ms. Carter has 30 students in her classroom. She arranges them into 5 equal groups. Which expression represents how to find the number of students in each group?

A $30 + 5$

B $30 \div 5$

C $30 - 5$

D 30×5

3. Jess scored 18 points during her last basketball game. Each basket she made was worth 2 points. How many baskets did she make?

A 20

B 16

C 9

D 8

4. A store manager orders shirts from their warehouse. The shirts are packed into boxes and sent to the store, as described below.

- 81 shirts are ordered
- each shipping box holds 9 shirts

How many shipping boxes are needed for all of the shirts ordered?

- A 8
- B 9
- C 72
- D 90

5. Coach Wu has a total of 30 soccer balls.

- 9 soccer balls are white
- the remaining soccer balls are one of three different colors (blue, pink, or green)
- there is an equal number of blue, pink, and green balls

How many green soccer balls does Coach Wu have?

- A 7
- B 10
- C 21
- D 39



Day # 3

NYS Math Exam Practice

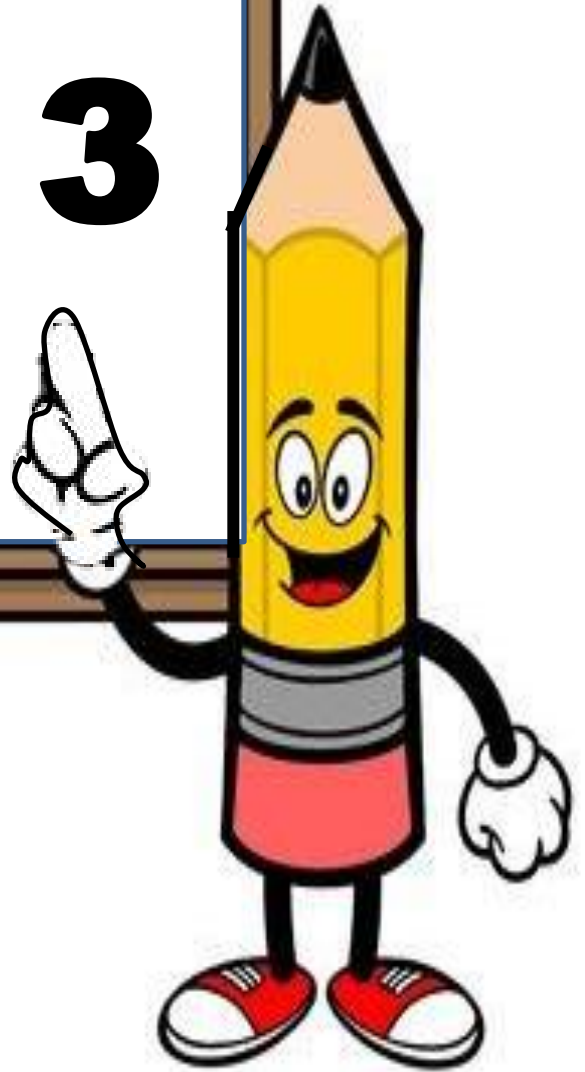

LEQ: How can I review rounding and time to be successful on the NYS math exam?

Objective: I can use a set of rules, take great notes, and ask/answer questions to review rounding and time to be successful on the NYS math exam.

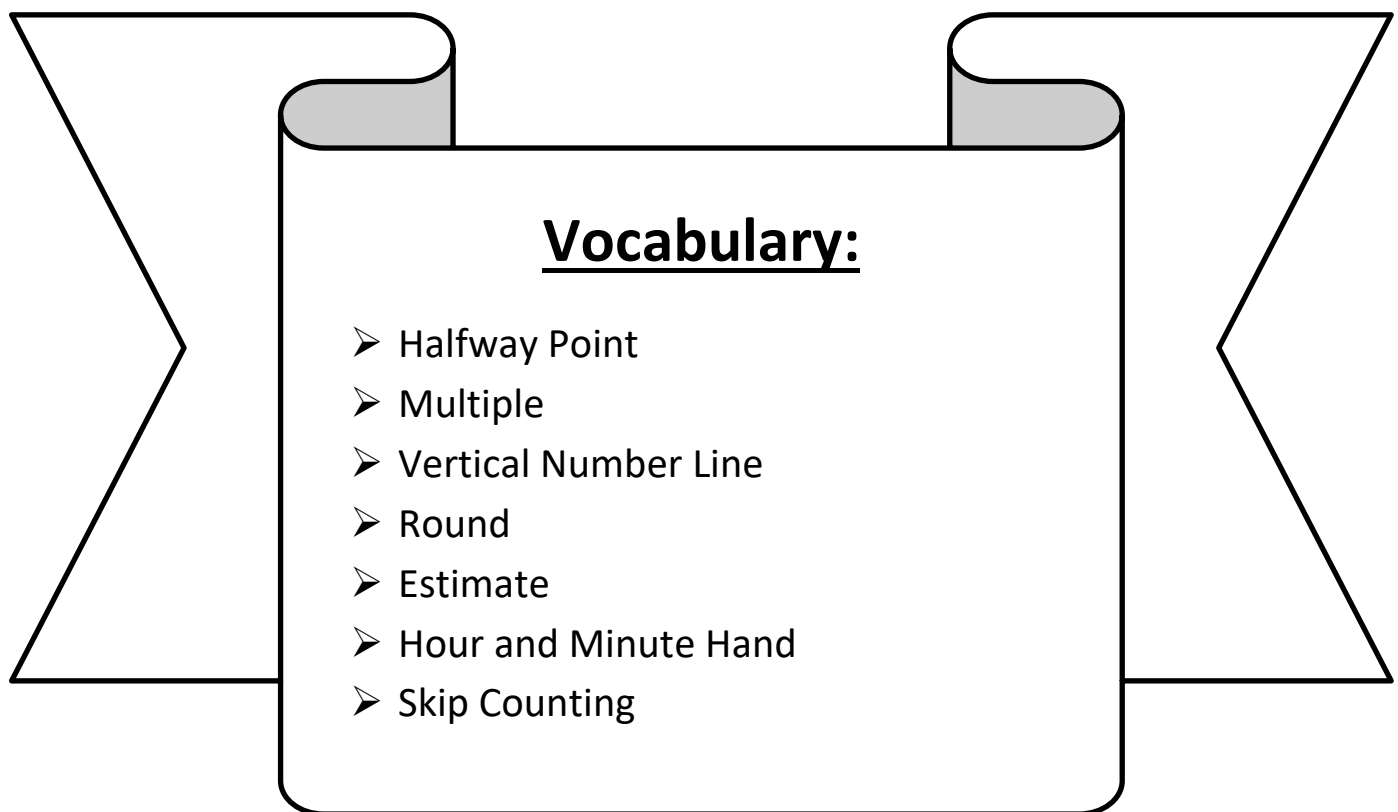

The number 68 has made it over the halfway point and will go forward to 70!

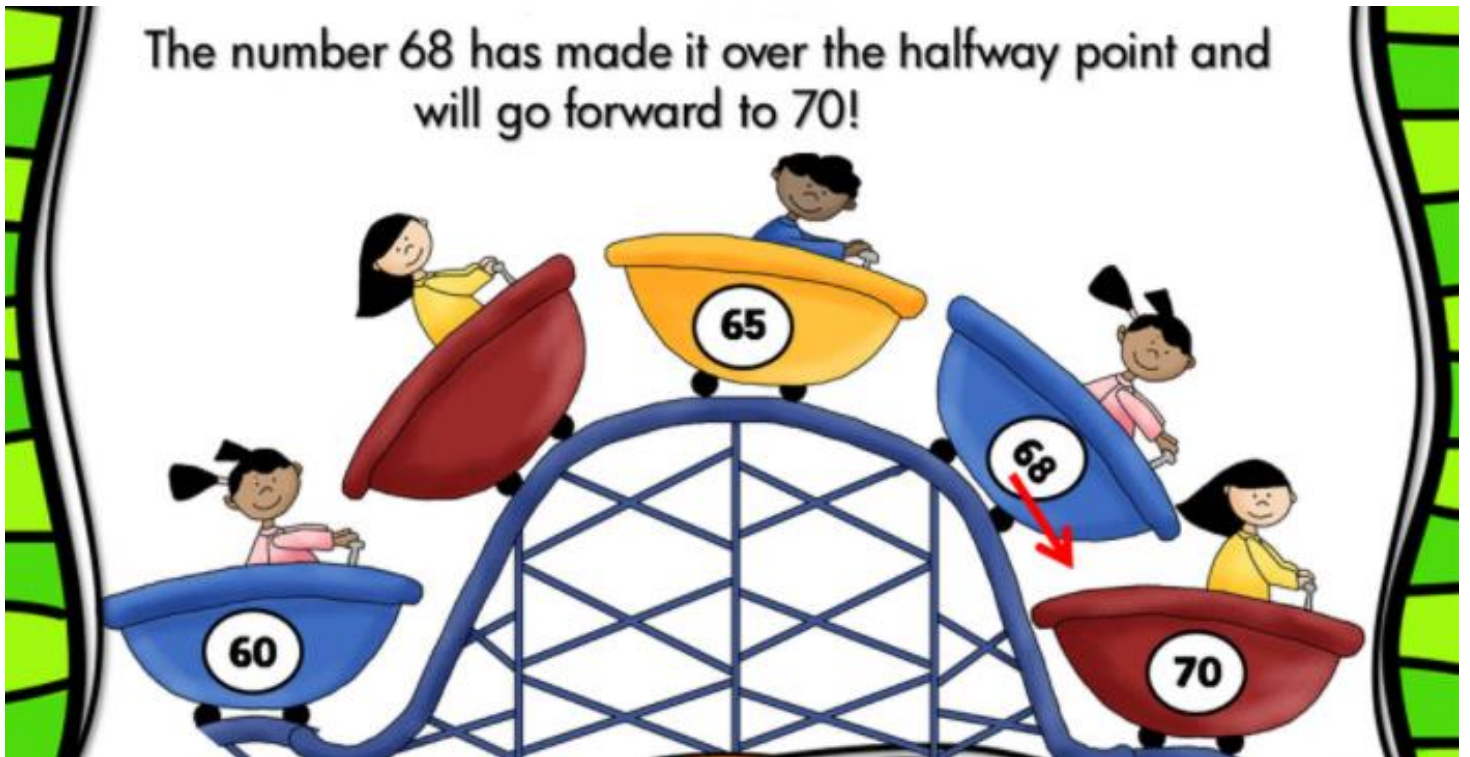

Rounding Rhyme

Five to nine -
Climb the vine!

8 8 \longrightarrow 90

9
8
7
6
5

Zero to four -
Slide to the floor!

6 3 \longrightarrow 60

4

3

2

1



ROUNDING

Underline the digit
look next door.

If it's 5 or greater
add one more.

If it's less than 5
leave it for sure.

Everything after
is a zero, not more.

Name: _____

Week 32 Day 3 Date: _____

BCCS-B

Harvard

Yale

Princeton

1. What is 637 rounded to the nearest ten?

- A 600
- B 630
- C 640
- D 647

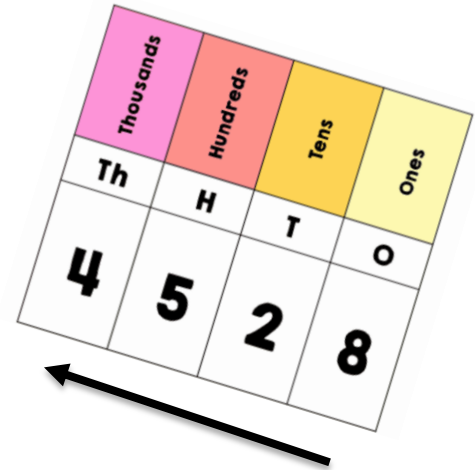

2. The table below shows the number of tickets for the school play that were sold each day.

SCHOOL PLAY TICKETS

Day	Number of Tickets Sold
Thursday	238
Friday	361
Saturday	249
Sunday	328

On which day does the number of tickets sold round to 300, when rounded to the nearest hundred?

- A Thursday
- B Friday
- C Saturday
- D Sunday

3. What is 836 rounded to the nearest 10?

A 800

B 830

C 840

D 870

4. A number belongs in the box below. When the number is rounded to the nearest hundred, the result will be 900.



Which number belongs in the box?

A 849

B 852

C 960

D 999

5. A coach rounded the number of runners at a track meet to the nearest 10. The rounded number of runners is 400. Which number could be the actual number of runners at the track meet?

A 382

B 397

C 406

D 447

6. The table below shows four numbers rounded to the nearest hundreds place. One of the numbers is rounded incorrectly.

Starting Number	Rounded to the Nearest Hundred
1,212	1,200
2,396	2,300
3,636	3,600
5,573	5,600

Which number is rounded to the nearest hundreds place incorrectly?

- A 1,212
 - B 2,396
 - C 3,636
 - D 5,573
7. The distance from Chicago to New York City is 794 miles. What is 794 rounded to the nearest hundred?
- A 700
 - B 794
 - C 800
 - D 894

TELLING TIME

STEP 1:

HOUR HAND



- Look at the small hand it's called the hour hand
- Look at the **LAST** number the hand passed
- Say the number and then look at the minute hand

STEP 2:

MINUTE HAND



- Look at the big hand it's called the minute hand
- Start at 12 and count by 5's
- If it's on the 12, just say o'clock!
- If it's on the 6, just say thirty!



Name: _____

Week 32 Day 3 Date: _____

BCCS-B

Harvard

Yale

Princeton

1. Pedro left home this morning at the time shown on the clock below.

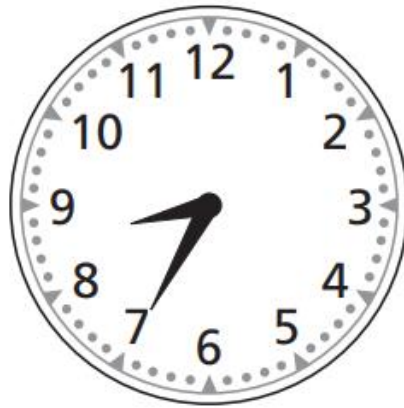

Tina left home 20 minutes after Pedro left. Carlos left home 18 minutes after Tina left. At what time did Carlos leave home this morning?

- A 7:57 a.m.
 - B 8:13 a.m.
 - C 8:38 a.m.
 - D 9:13 a.m.
2. Which clock shows the time 7:08?

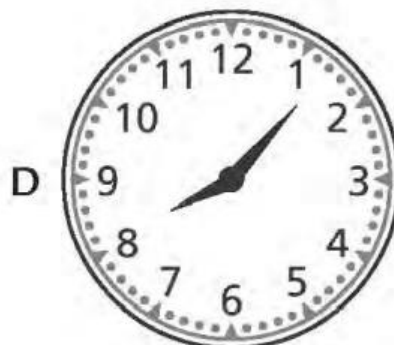
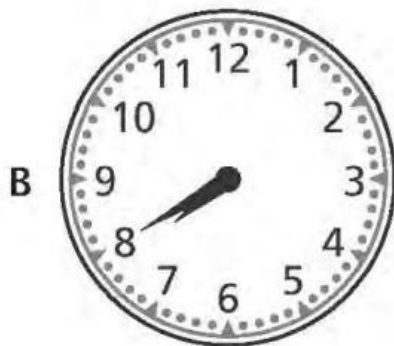
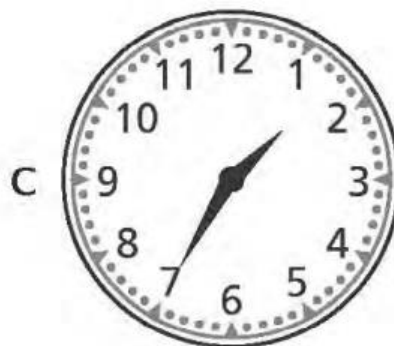
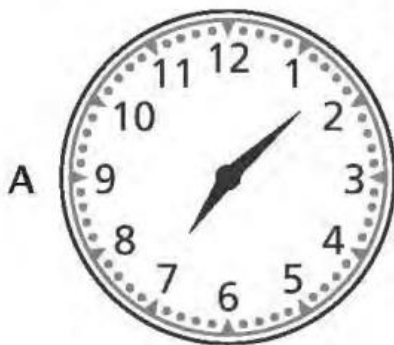

3. Last weekend Sanjay watched 3 television shows that were each 30 minutes long. He also watched 1 movie on television that was 90 minutes long. What is the total number of minutes Sanjay watched television last weekend?
- A 100
 - B 120
 - C 150
 - D 180
4. Beth met her friends at the library at 4:30 p.m. It took her 24 minutes to walk from her house to the library. What time did Beth leave her house to arrive at the library at exactly 4:30 p.m.?

Show your work.

5. Frankie's music class begins at 9:40 a.m. The class is 45 minutes long. Which clock shows the time that Frankie's class ends?

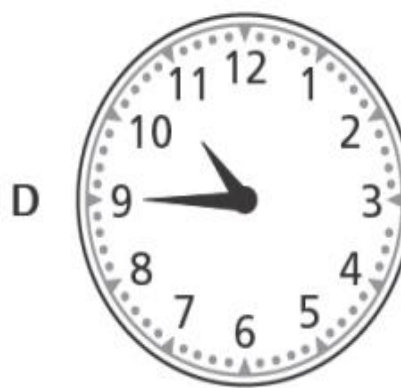
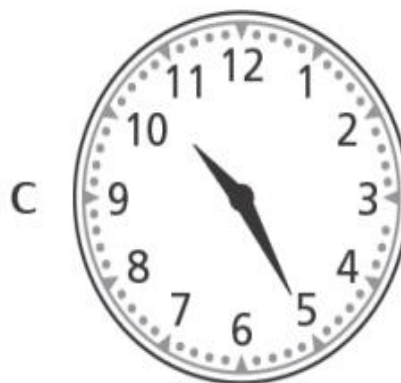

6. Joe and Mike both ran the same race. Joe finished the race 4 minutes before Mike. If Mike finished the race at 4:02 p.m., what time did Joe finish the race?

- A 3:58 p.m.
- B 4:06 p.m.
- C 8:02 p.m.
- D 12:02 p.m.

Name: _____

Week 32 Day 3 Date: _____

BCCS-B

Harvard

Yale

Princeton

Homework:

1. A number is rounded to the nearest hundred. The result is 500. Which number could **not** be the number before it was rounded to the nearest hundred?

A 458

B 463

C 547

D 559

2. Suzy made cupcakes for her friends. She started at 2:40 p.m. The list below shows the number of minutes it took to complete each step of the process.
 - 9 minutes to mix the batter
 - 18 minutes to bake the cupcakes
 - 5 minutes to let them cool
 - 10 minutes to frost the cupcakes

What time did Suzy finish frosting the cupcakes?

Show your work.



Day # 4

NYS Math Exam Practice

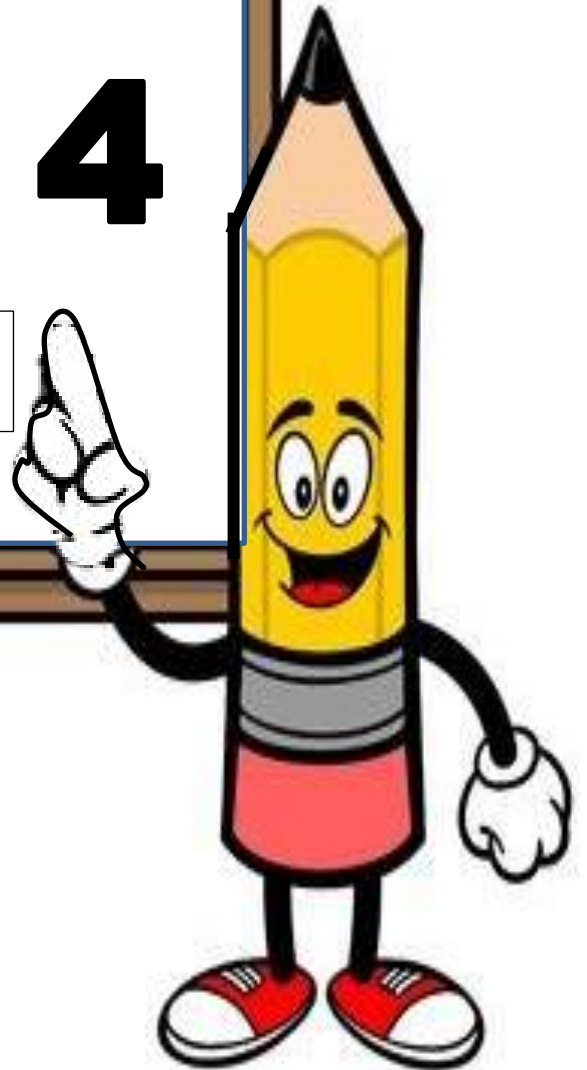

LEQ: How can I review word problems to be successful on the NYS math exam?

Objective: I can use CUBES, organize my work space, take great notes, and ask/answer questions to review word problems and be successful on the NYS math exam.

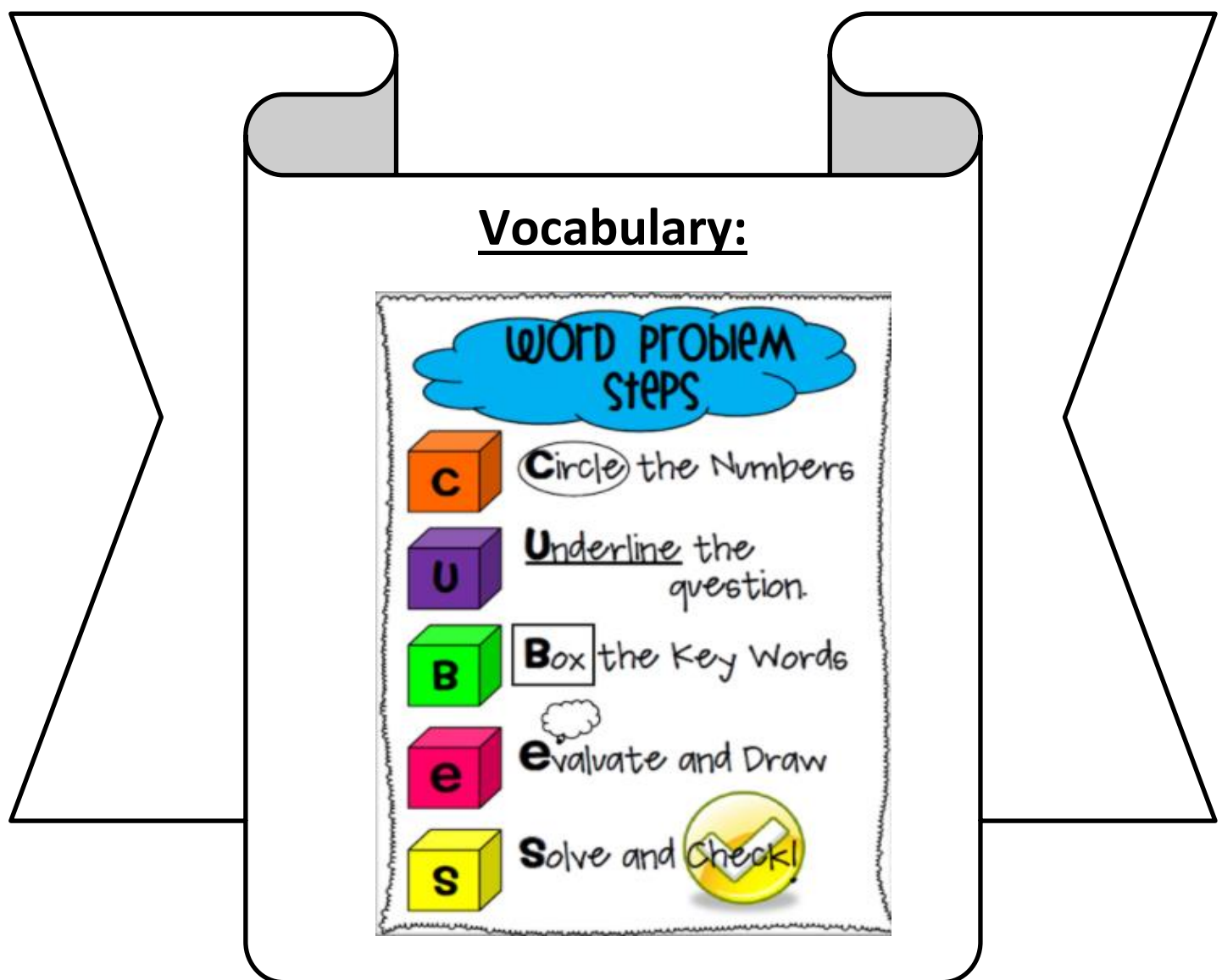

Circle the numbers

H Tom looked across the yard and saw 3 blue birds and 5 yellow birds. How many birds did Tom see in all?



Eliminate extra information

P The store has different colors of glasses. There are 23 purple, 14 pink, and 25 blue. How many glasses were there in all?



Underline the question

T My dad had 56 nails in his pocket. He used 25 of the nails. How many nails are left in his pocket?



Solve and check

K In gym there were 4 red, 5 green, and 2 purple hoola hoops. How many hoola hoops were there in all?



$$\begin{array}{r} 4 \\ + 5 \\ + 2 \\ \hline 11 \end{array}$$

Name: _____

Week 32 Day 4 Date: _____

BCCS-B

Harvard

Yale

Princeton

1. Selena had 204 stamps in her collection. She bought 47 more stamps. If she gave 38 stamps to her brother, how many stamps does Selena have now?

A 119

B 195

C 213

D 289



2. Mr. Kohlberg owns a flower shop. At the beginning of the day, he had 152 roses. Mr. Kohlberg sold 96 of the roses and then wanted to separate the rest of the roses equally among 8 vases. What will be the total number of roses in each vase?

A 7

B 12

C 48

D 56

3. Mrs. Allen made 8 pitchers of fruit punch for a party. She used 2 liters of water to make each pitcher of fruit punch. How many liters of water did Mrs. Allen use in all?

- A 4
- B 6
- C 10
- D 16

4. Maddie will ride her bike a total of 56 miles over 7 days. She will ride the same number of miles each day. What is the total number of miles Maddie will ride each day?

- A 8
- B 9
- C 49
- D 63

Day 1	
Day 2	
Day 3	
Day 4	
Day 5	
Day 6	
Day 7	

5. Noel read 90 minutes each day for 6 days. Tyra read 60 minutes each day for 8 days. What is the difference, in minutes, between the total amount of time Noel read and the total amount of time Tyra read?
- A 30
 - B 40
 - C 60
 - D 80
6. Colton and his dad bought a gallon of paint that cost \$13. They also bought 2 brushes that cost \$9 each. What was the total cost, not including tax, of the brushes and the paint they bought?
- A \$22
 - B \$24
 - C \$31
 - D \$35

7. Carmen saved 592 pennies. Her sister saved 128 pennies. Together, they put 250 pennies in wrappers and took them to the bank. What is the total number of pennies, rounded to the nearest hundred, Carmen and her sister have left?

- A 300
- B 500
- C 700
- D 1,000



8. There are 12 students in Ms. Miller's class. She needs 24 juice boxes for a class party. The juice boxes come in packages of 6 juice boxes each. Which expression represents the number of packages of juice boxes Ms. Miller needs to buy for the class party?

- A $24 + 12$
- B $36 \div 6$
- C 12×6
- D $24 \div 6$

9. Conor made 9 shapes with straws. Each shape had 5 straws. Conor used 15 more straws to make more shapes. What is the total number of straws Conor used to make all the shapes?

- A 20
- B 29
- C 45
- D 60

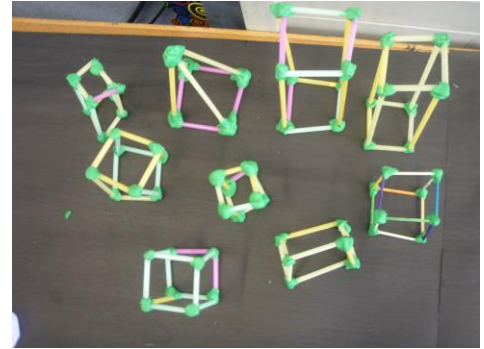

10. A store has 8 fish tanks that each have 40 liters of water. What is the total number of liters of water in all of the fish tanks?

- A 5
- B 48
- C 280
- D 320

11. Mrs. Ruiz bought 5 bags of balloons for a party. Each bag contained 70 balloons. Andy said Mrs. Ruiz bought a total of 75 balloons. Andy is incorrect.

What error did Andy make when calculating the total number of balloons?

Andy made an error when he

What is the total number of balloons Mrs. Ruiz bought?

Show your work.

12. A tennis coach buys 8 cans of tennis balls. There are 3 tennis balls in each can. All of the tennis balls will be shared equally among 6 players. How many tennis balls will each player get?

Show your work.

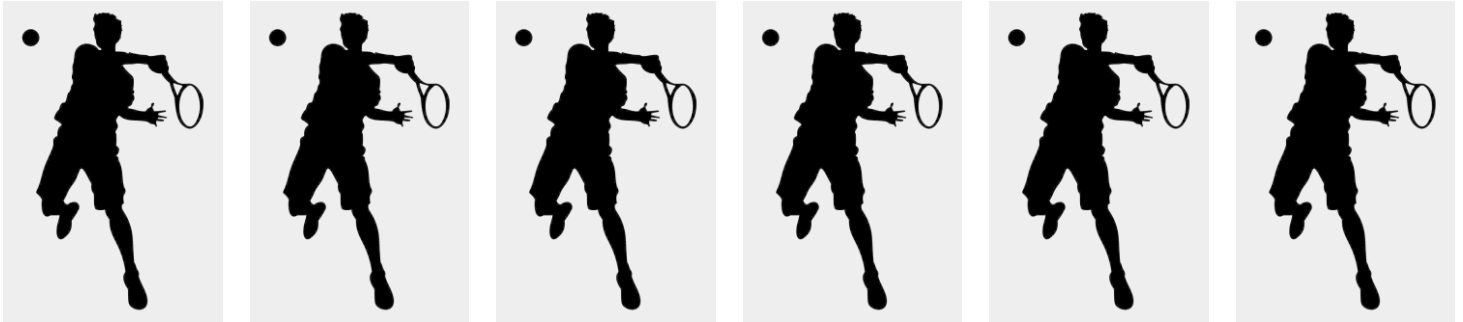

Each player will get _____ tennis balls.

14. Ms. Ross is making breakfast for her family. She makes 15 small pancakes to share equally among 3 people. How many small pancakes will each person get?

Show your work.

Answer _____ pancakes

4 miles each day

15. Ashlynn rides her bike 2 miles to school and 2 miles home each day. How many total miles will Ashlynn ride her bike to school and home in 40 days?

Show your work.

Name: _____

Week 32 Day 4 Date: _____

BCCS-B

Harvard

Yale

Princeton

Homework:

1. A teacher puts 5 packages of craft paper into a cabinet. Each package has 80 sheets of paper. What is the total number of sheets of craft paper that the teacher puts into the cabinet?

- A 40
- B 85
- C 400
- D 450

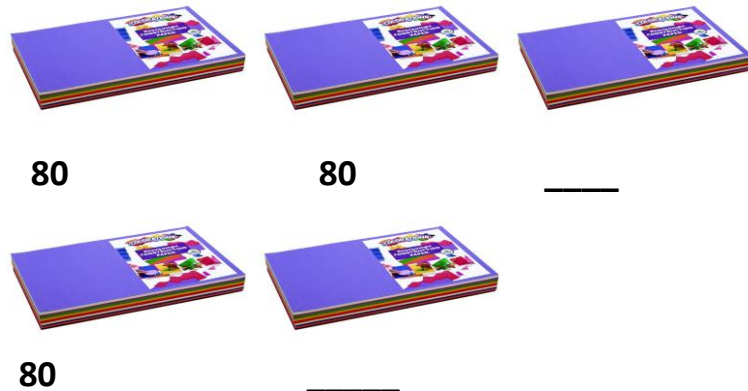

2. A librarian receives two boxes of books for the library. The first box has 136 books. The second box has 58 fewer books than the first box. What is the total number of books the librarian receives?

- A 58
- B 78
- C 194
- D 214

Fewer= subtract



Day # 5

NYS Math Exam Practice

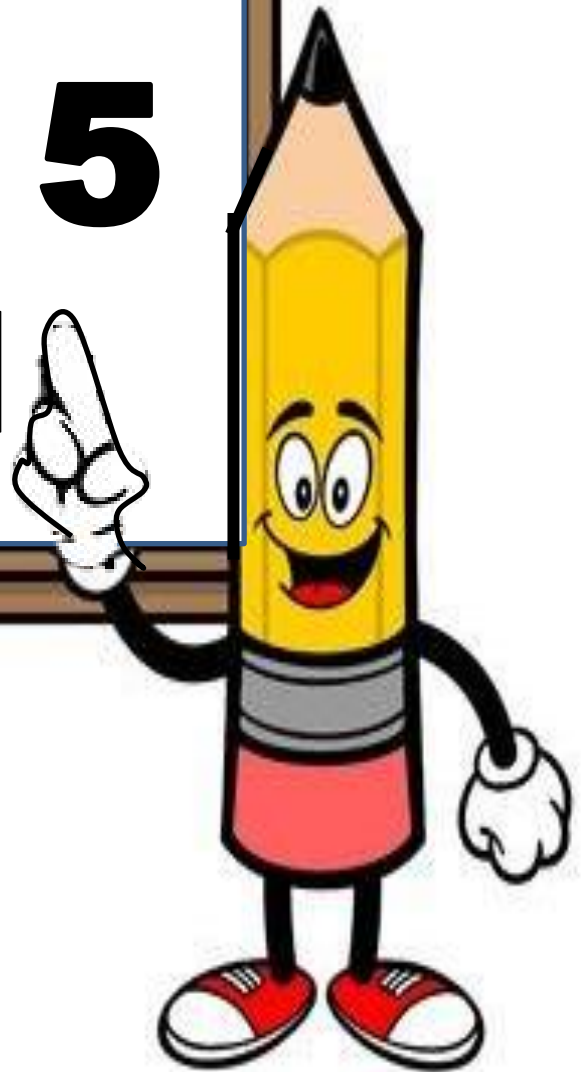

LEQ: How can I review measurement and the distributive property to be successful on the NYS math exam?

Objective: I can take great notes, organize my work space, take great notes, and ask/answer questions to review measurement and the distributive property and be successful on the NYS math exam.

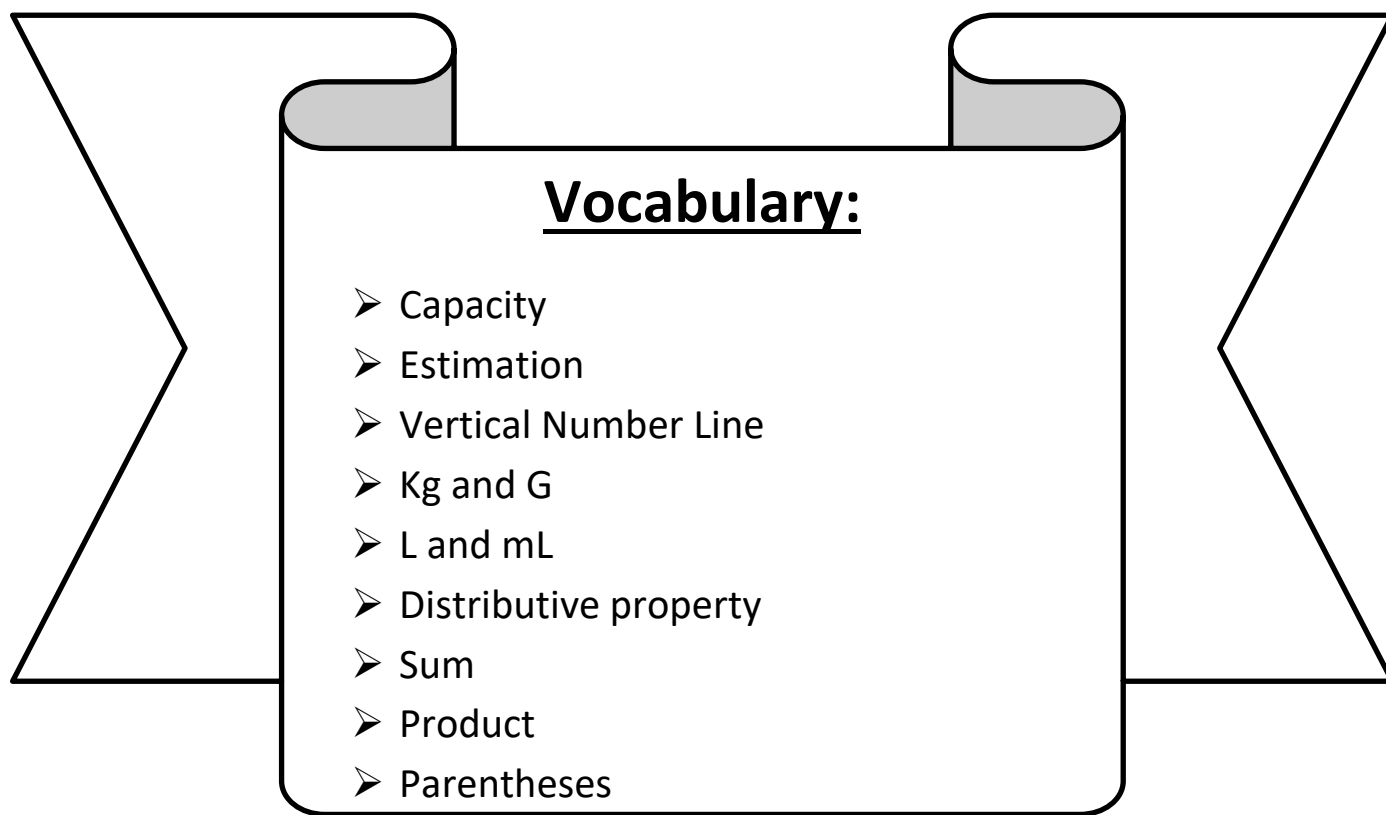



A paperclip is about 1 gram



A heavy book is about 1 kilogram

$1,000 \text{ grams (g)} = 1 \text{ kilogram (kg)}$



A few drops is about 1 milliliter



A large water bottle is about 1 liter

$1,000 \text{ milliliters (mL)} = 1 \text{ liter (L)}$

Use grams and kilograms to measure mass.

When you hear **GRAM** imagine holding a paperclip.

When you hear **KILOGRAM** imagine holding a dictionary.

↑ the amount of matter an object has.

$1 \text{ kilogram (kg)} = 1,000 \text{ grams (g)}$

One way to think about it... 1 kg

10g	10g	10g	10g	10g	100g
100g	100g	100g	100g	100g	100g
100g	100g	100g	100g	100g	100g
100g	100g	100g	100g	100g	100g
100g	100g	100g	100g	100g	100g

Measuring Liquid

Capacity: the maximum amount something can hold. (container)

The capacity of this water bottle is 1 L. When it is full, there is 1 L of water in it.

liquid volume: the amount of space liquid takes up.

The liquid in the container has a volume of 12 L.

We can use liters and milliliters to measure amounts of liquid.

$1,000 \text{ mL} = 1 \text{ L}$

When you think of 1 mL, think of a drop of water.

When you think of 1 L, think of a carton of juice.

Name: _____

Week 32 Day 5 Date: _____

BCCS-B

Harvard

Yale

Princeton

1. The picture below shows that one box is heavier than 5 identical cans.

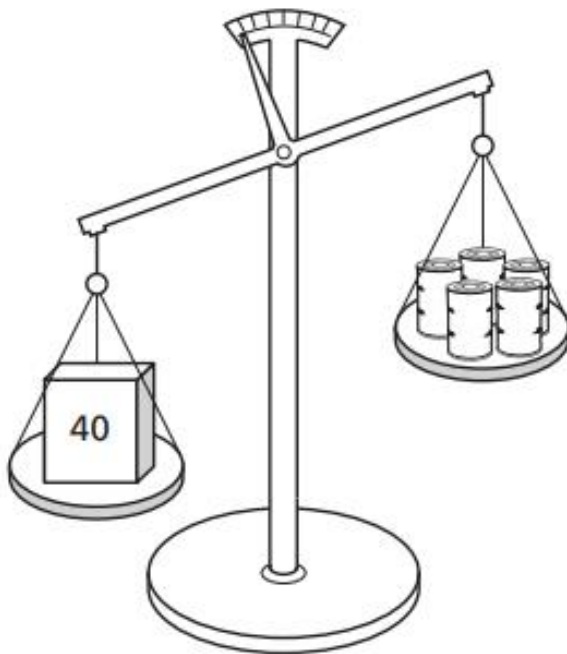

The box has a mass of 40 kilograms. What could be the mass, in kilograms, of 1 can?

- A** 40
- B** 10
- C** 8
- D** 6

2. A third-grade class is having a car wash. They put the same amount of water in each bucket, as shown.

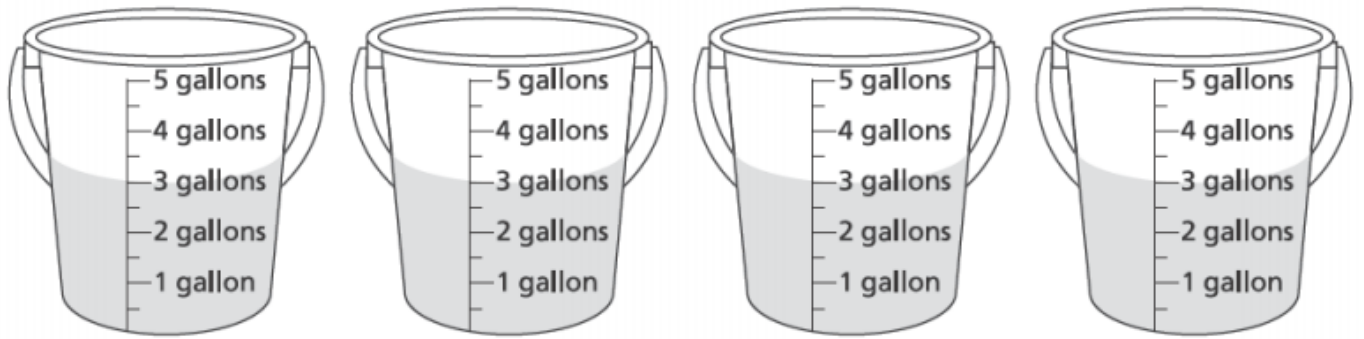

Which expression can be used to find the total amount of water, in gallons, in all the buckets?

- A 4×3
- B 5×3
- C 4×4
- D 5×4

3. Kara has a bucket of water, as shown below.

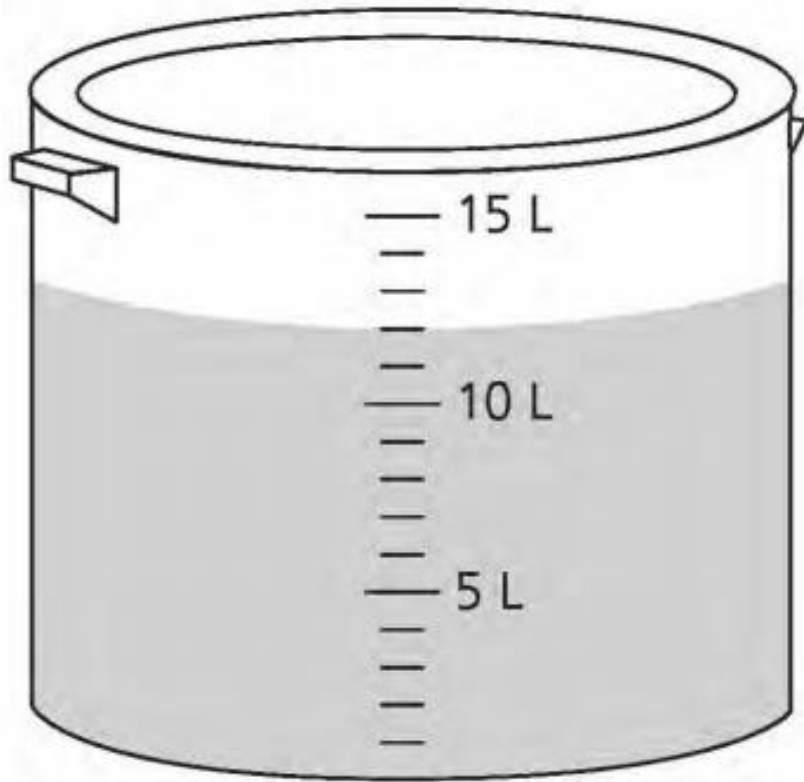

Kara wants to pour all of the water equally into 3 bowls for her dogs. How many liters of water should Kara pour into each bowl?

- A 4
- B 5
- C 9
- D 15

4. The picture below shows that 3 cans have the same mass as 9 identical boxes.
Each can has a mass of 30 grams.

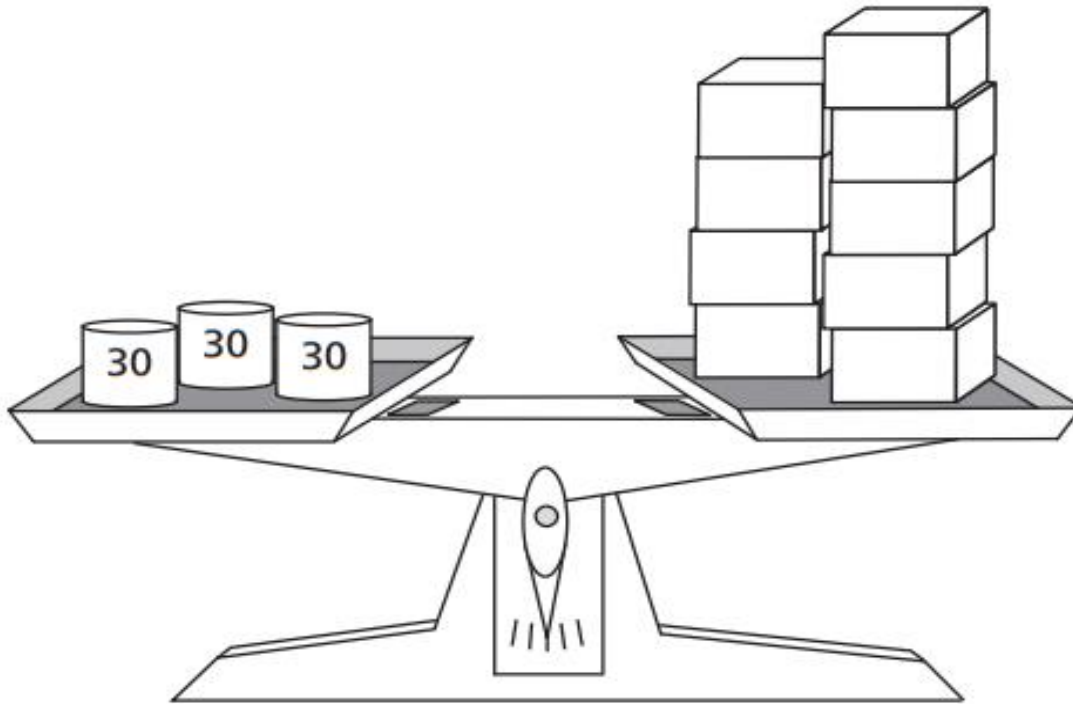

What is the mass, in grams, of each box?

Show your work.

Answer _____ grams

Distributive Property = Fact Fluency

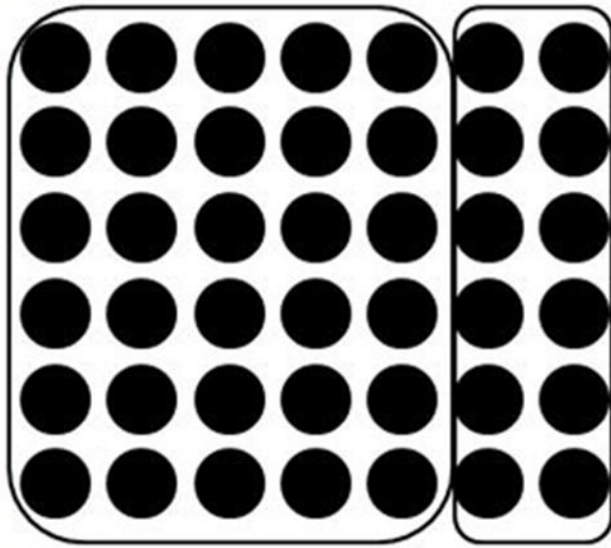

$$6 \times 7 = \square$$

$$6 \times (5 + 2) = \square$$

$$(6 \times 5) + (6 \times 2) = \square$$

 MATH COACH'S CORNER

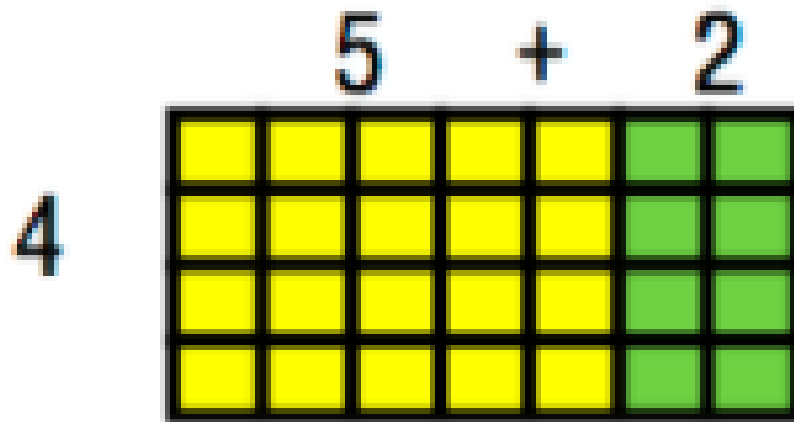

$$\begin{aligned} 4 \times 7 &= 4 \times (5 + 2) \\ &= (4 \times 5) + (4 \times 2) \\ &= 20 + 8 \\ &= 28 \end{aligned}$$

Name: _____

Week 32 Day 5 Date: _____

BCCS-B

Harvard

Yale

Princeton

1. Which expression is equivalent to $(5 + 2) \times 8$?

A $(8 \times 5) + (8 \times 2)$

B $(5 \times 8) + (5 \times 2)$

C $8 \times (5 \times 2)$

D $(5 \times 8) \times 2$

2. Which expression is equivalent to 4×9 ?

A $(4 \times 4) + (4 \times 5)$

B $(4 + 4) \times (4 + 5)$

C $(4 + 4) + (4 + 5)$

D $(4 \times 4) \times (4 \times 5)$

3. Which expression is another way to show 8×6 ?

A $(2 + 4) + 6$

B $(2 + 4) \times 6$

C $(2 \times 4) + 6$

D $(2 \times 4) \times 6$

4. Last week, Paul ate 2 cookies each day for 5 days. This week, he ate 2 cookies each day for 4 days. Which expression can be used to represent the total number of cookies Paul ate in these two weeks?

- A** $2 \times (5 \times 4)$
- B** $2 \times (5 + 4)$
- C** $(2 \times 5) \times (2 \times 4)$
- D** $(2 + 5) \times (2 + 4)$

5. Which expression is equivalent to 5×9 ?

- A** $(5 \times 4) \times (5 \times 5)$
- B** $(5 \times 5) + (5 \times 4)$
- C** $(5 \times 5) + (5 \times 9)$
- D** $(5 \times 9) \times (5 \times 9)$

6. Which expression has the same value as $(8 \times 5) + (8 \times 3)$?

- A** 8×8
- B** 8×15
- C** $16 + 8$
- D** $13 + 11$

7. Mr. Nuccio's sandwich shop was 9 yards long and 7 yards wide before he added a new section. The shaded squares below show the new section.

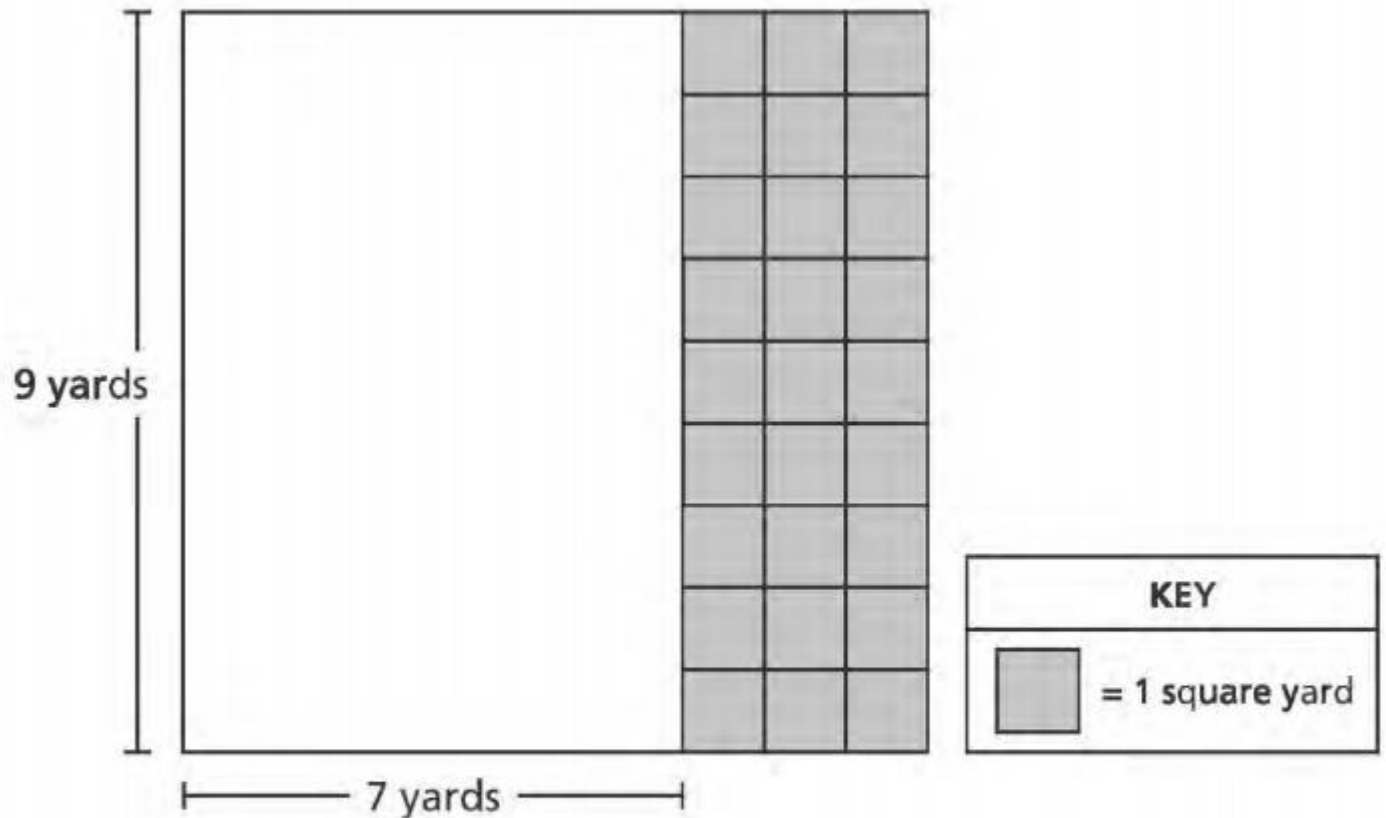

What is the total area, in square yards, of Mr. Nuccio's sandwich shop after the new section was added?

Show your work.

8. Paul has gray and white paving stones in his patio. A diagram of his patio is shown below.

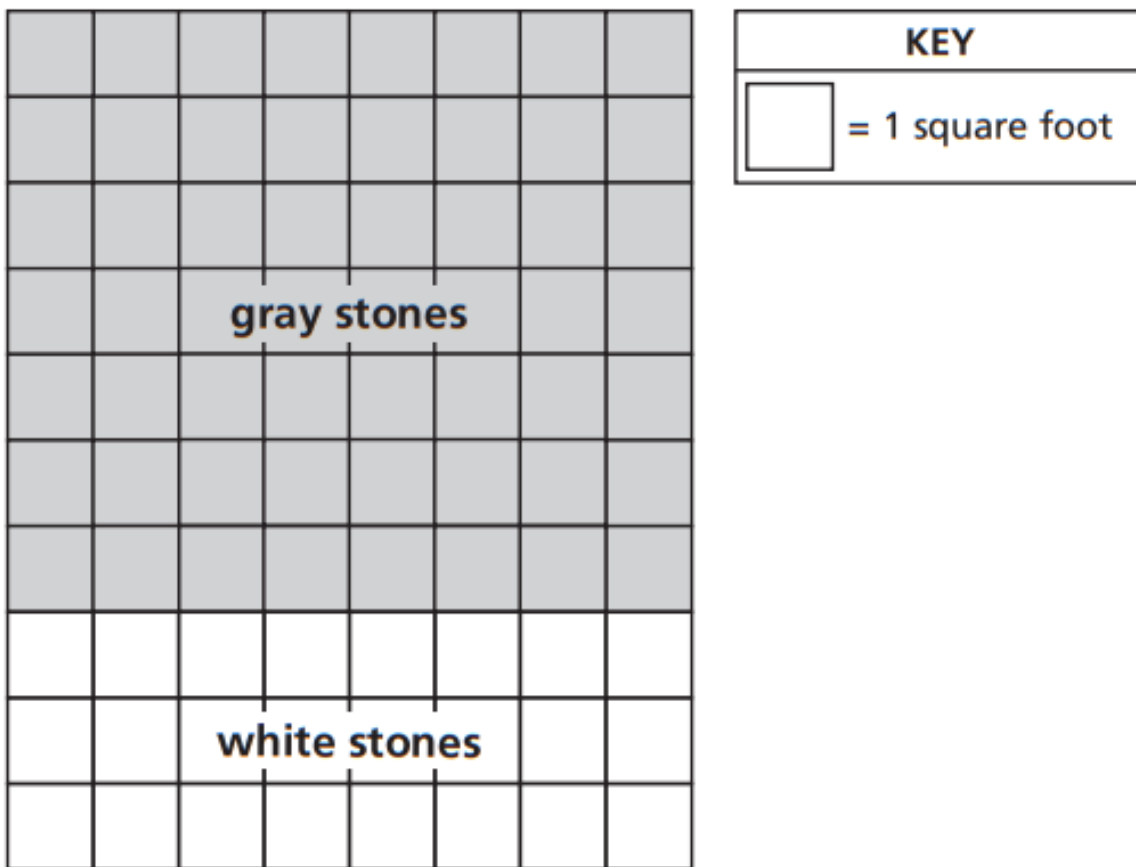

Which equation can be used to find the total area, in square feet, of Paul's patio?

- A** $(8 \times 7) + (8 \times 3) = \underline{\quad? \quad}$
- B** $(8 + 7) \times (8 + 3) = \underline{\quad? \quad}$
- C** $(10 \times 7) + (10 \times 3) = \underline{\quad? \quad}$
- D** $(10 + 7) \times (10 + 3) = \underline{\quad? \quad}$

Name: _____

Week 32 Day 5 Date: _____

BCCS-B

Harvard

Yale

Princeton

Exit Ticket:

Read each graduated cylinder and write the amount. Be sure to include **mL** in your answer.

a.

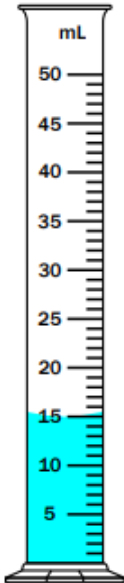

b.

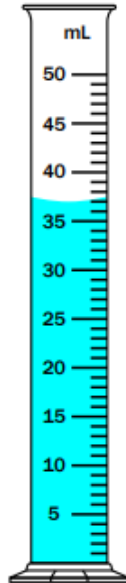

c.

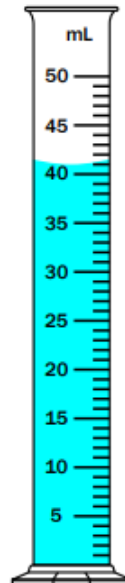

d.

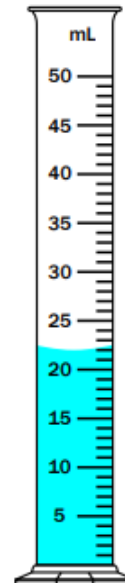

15 mL _____

Write the answer to each number sentence.

a. $2 \times (8 + 1) =$ _____

b. $(6 \times 3) + (6 \times 7) =$ _____

c. $3 \times (4 + 1) =$ _____

d. $(8 \times 2) + (8 \times 1) =$ _____

e. $8 \times (4 + 3) =$ _____

f. $(12 \times 1) + (12 \times 0) =$ _____

g. $4 \times (2 + 2) =$ _____

h. $(5 \times 7) + (5 \times 1) =$ _____

i. $9 \times (3 + 6) =$ _____

j. $(1 \times 99) + (1 \times 1) =$ _____



Name _____

3rd Grade Modified Math Remote Learning Packet

Week 33

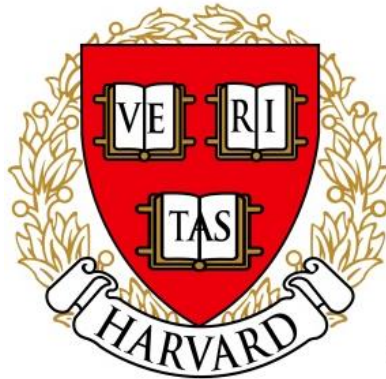

Dear Educator,

My signature is proof that I have reviewed my scholar's work and supported him to the best of my ability to complete all assignments.

(Parent Signature)

(Date)

Parents please note that all academic packets are also available on our website at www.brighterchoice.org under the heading "Remote Learning." All academic packet assignments are mandatory and must be completed by all scholars.



Day # 1

NYS Math Exam Practice

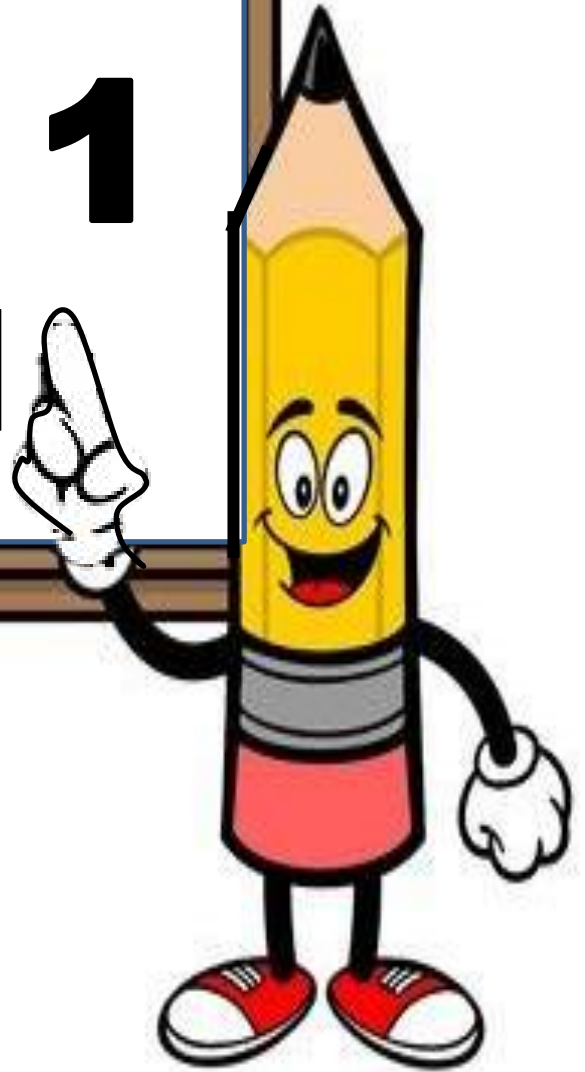

LEQ: How can I review multiplication to be successful on the NYS math exam?

Objective: I can organize my work space, take great notes, and ask/answer questions to review multiplication and be successful on the NYS math exam.

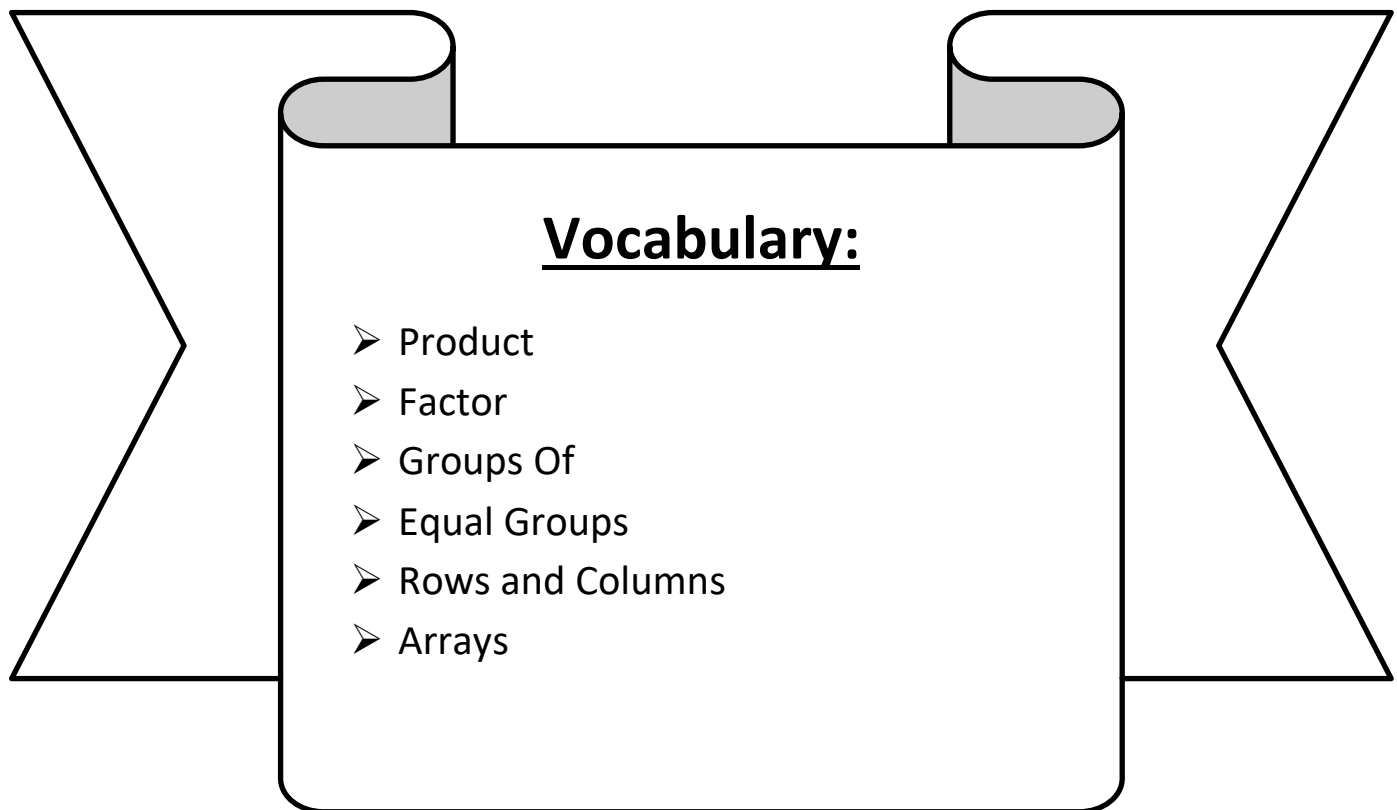

MULTIPLICATION STRATEGIES

Equal Groups

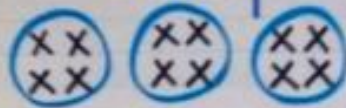

$$3 \times 4 = 12$$

groups with equal # in each

Repeated Addition

$$4 + 4 + 4 = 12$$

$$3 \times 4 = 12$$

Array

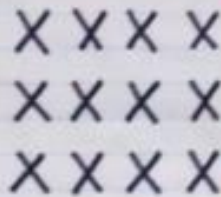

$$3 \times 4 = 12$$

rows with equal # in each

$$5 \times 3$$

1 →



2 →



3 →



4 →



5 →



“5 equal groups of 3”

$$3 + 3 + 3 + 3 + 3$$

Name: _____

Week 33 Day 1 Date: _____

BCCS-B

Harvard

Yale

Princeton

6 x 4

Arrays	Equal Groups	Repeated Addition
		<div data-bbox="1101 491 1503 617" style="border: 1px solid black; padding: 5px;">$6 + 6 + 6 + 6 =$</div>

4 x 7

Arrays	Equal Groups	Repeated Addition

9 x 3

Arrays	Equal Groups	Repeated Addition

Name: _____

Week 33 Day 1 Date: _____

BCCS-B

Harvard

Yale

Princeton

1. Which expression could be used to find the total number of circles shown below?

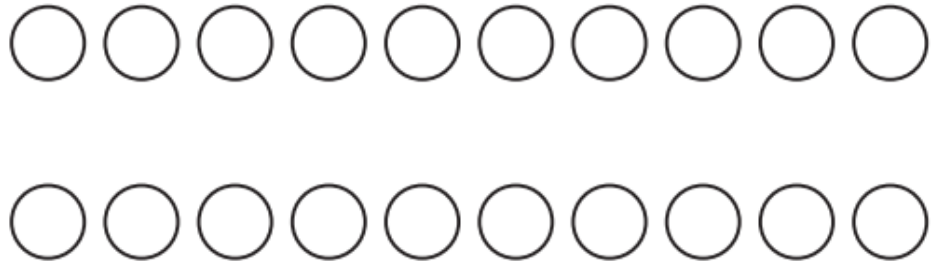

- A** $2 + 20$
- B** 2×20
- C** $2 + 10$
- D** 2×10
2. Umi created the number pattern below by adding the same amount each time to get the next number.

20, 40, 60, 80, . . .

What will be the eighth number in the pattern?

- A** 160
- B** 240
- C** 320
- D** 640

Skip count by 20

3. The table shows the total number of wheels Mr. Monroe needs to make different numbers of wagons.

WHEELS NEEDED FOR WAGONS

Number of Wagons	Total Number of Wheels
1	4
2	8
3	12
4	16

What is one pattern that can be seen in the table?

- A The number of wheels increases by 1 each time.
- B The number of wheels increases by 3 each time.
- C The number of wheels increases by 4 each time.
- D The number of wheels increases by 12 each time.
4. A group of students played a basketball game after school. Which total can be found using the expression 7×2 ?
- A the total number of points if a player made 7 shots and each shot was worth 2 points
- B the total number of basketballs if 7 basketballs were old and 2 basketballs were new
- C the total number of points if one player had 7 points and a different player had 2 points
- D the total number of basketballs used if there were 7 basketballs and 2 of the basketballs were not used

5. Which expression is equal to 720?

A 7×20

B 8×80

C 9×80

D 9×90

6. Which situation could be represented by the expression 6×2 ?

A Rocco hiked six miles each day for two days.

B Rocco had six baseballs and gave away two of them.

C Rocco had a total of six tennis balls in two cans.

D Rocco biked six miles and then continued for two more miles.

7. There were set up for a meeting. What was the total number of chairs set up for the meeting?

A 14

B 36

C 48

D 64

8. Katia received a sticker each time she picked up her toys. She placed some of the stickers on page 1 of her scrapbook, as shown below.

Page 1



Write numbers in the blanks below to show two multiplication facts represented by the array of stickers on page 1 of her scrapbook.

$$\underline{\quad} \times \underline{\quad} = \underline{\quad}$$

$$\underline{\quad} \times \underline{\quad} = \underline{\quad}$$

Katia placed the rest of the stickers on pages 2 and 3 of her scrapbook, as shown below.

Page 2



Page 3



Complete the expression below to represent the total number of stickers on pages 2 and 3.

$$\underline{\quad} \times (\underline{\quad} + \underline{\quad})$$

9. A total of 30 players will play basketball at a park. There will be exactly 5 players on each team. Which statement correctly explains how to find the number of teams needed?

- A Add 5 to 30 to find 35 teams.
- B Divide 30 by 5 to find 6 teams.
- C Multiply 30 and 5 to find 150 teams.
- D Subtract 5 from 30 to find 25 teams.

10. A number pattern is shown below.

5, 9, 13, 17, 21, 25, 29

Which rule could have been used to make the pattern?

- A Start with 0. Add 4 each time to get the next number.
 - B Start with 0. Add 5 each time to get the next number.
 - C Start with 5. Add 4 each time to get the next number.
 - D Start with 5. Add 5 each time to get the next number.
11. Lucy is counting by 2s. She starts with the number 2 and stops at the number 50. Which number would Lucy **not** count?
- A 11
 - B 22
 - C 34
 - D 48

12. Ethan made the array below to show the product of 6×7 .

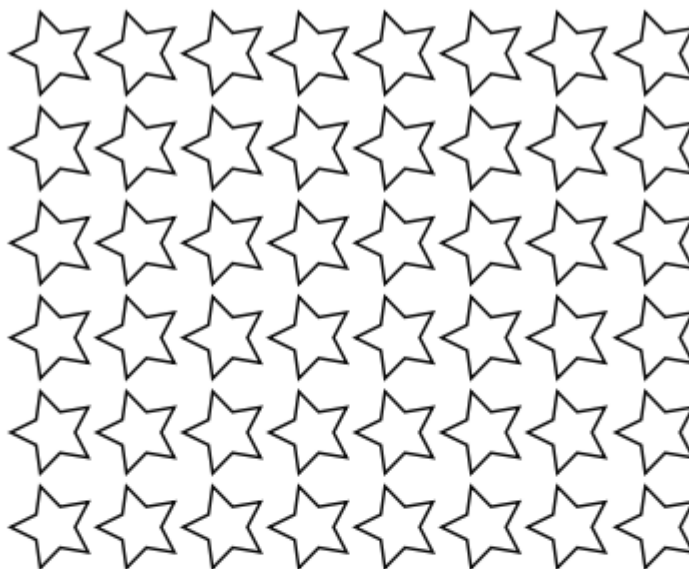

Does Ethan's model show the product of 6×7 ? Explain why or why not.

Answer

Ethan's model shows

Name: _____

Week 33 Day 1 Date: _____

BCCS-B

Harvard

Yale

Princeton

Homework:

1. Wyatt wants to solve the equation below to find the missing factor.

$$8 \times \underline{\quad ? \quad} = 24$$

How can Wyatt find the missing factor by changing the equation to a division problem? Be sure to include the value of the missing factor in your answer.

Explain your answer.

2. A bulletin board can be covered completely by 30 square pieces of paper without any gaps or overlaps. If each piece of paper has side lengths of 1 foot, what is the total area of the bulletin board?

- A 1 foot
- B 30 feet
- C 1 square foot
- D 30 square feet

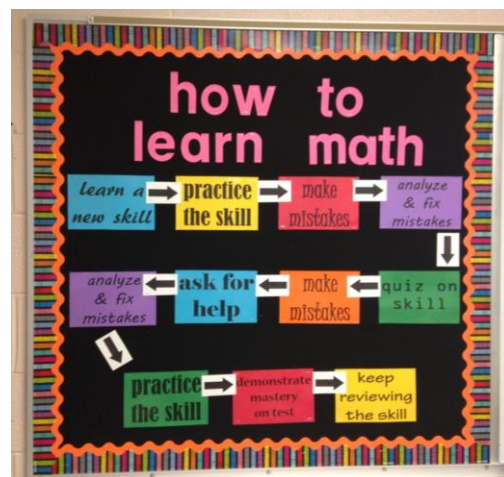



Day # 2

NYS Math Exam Practice

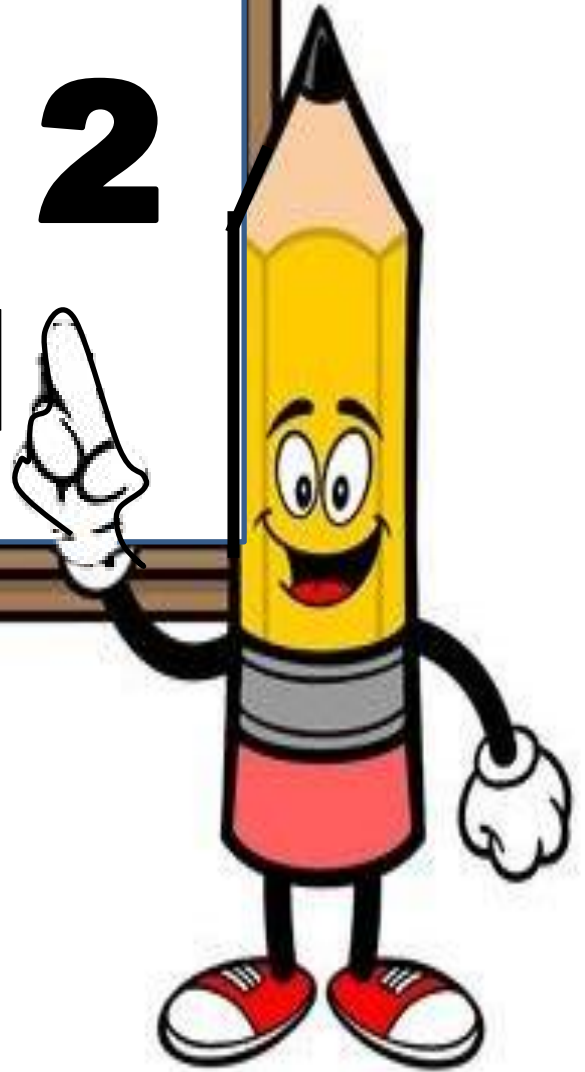

LEQ: How can I review visual data and even/odd numbers to be successful on the NYS math exam?

Objective: I can organize my work space, take great notes, and ask/answer questions to review visual data and even/odd numbers and be successful on the NYS math exam.

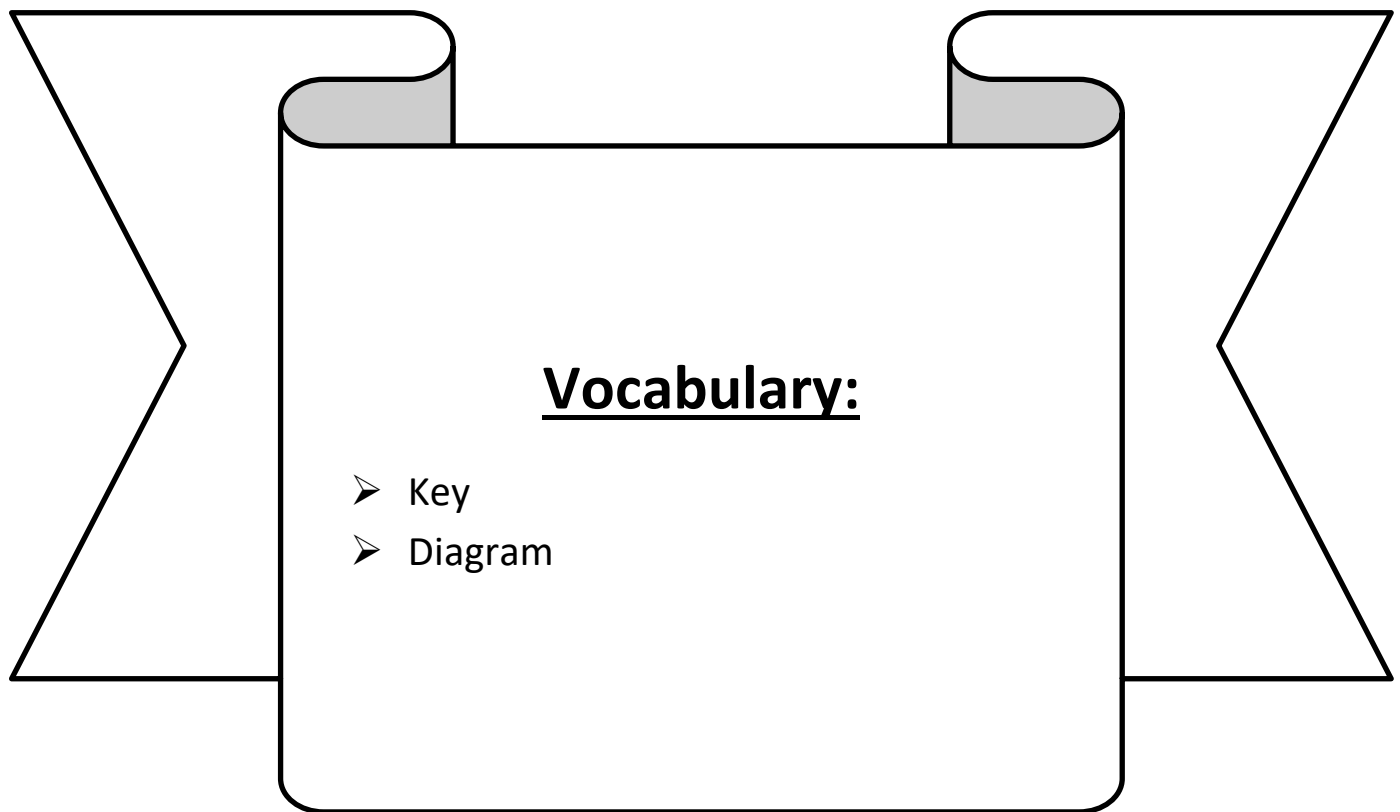

Name: _____

Week 33 Day 2 Date: _____

BCCS-B

Harvard

Yale

Princeton

1. The tally chart below shows the favorite seasons of Mr. Slater's students.

OUR FAVORITE SEASONS

Season	Number of Students
Spring	
Summer	/
Fall	
Winter	/

Which picture graph correctly shows the data?

OUR FAVORITE SEASONS

A

Season	Number of Students
Spring	🍷🍷🍷🍷
Summer	🍷🍷🍷🍷🍷🍷
Fall	🍷🍷
Winter	🍷🍷🍷🍷🍷🍷🍷🍷

KEY
🍷 = 2 students

OUR FAVORITE SEASONS

C

Season	Number of Students
Spring	🍷🍷🍷
Summer	🍷🍷🍷
Fall	🍷
Winter	🍷🍷🍷🍷

KEY
🍷 = 2 students

OUR FAVORITE SEASONS

B

Season	Number of Students
Spring	🍷🍷
Summer	🍷🍷🍷
Fall	🍷🍷
Winter	🍷🍷🍷🍷

KEY
🍷 = 2 students

OUR FAVORITE SEASONS

D

Season	Number of Students
Spring	🍷🍷
Summer	🍷🍷🍷
Fall	🍷
Winter	🍷🍷🍷🍷

KEY
🍷 = 2 students

2. Mr. Stone asked each of his students to name one favorite hobby. He made the picture graph shown below to display the data.

STUDENTS' FAVORITE HOBBIES

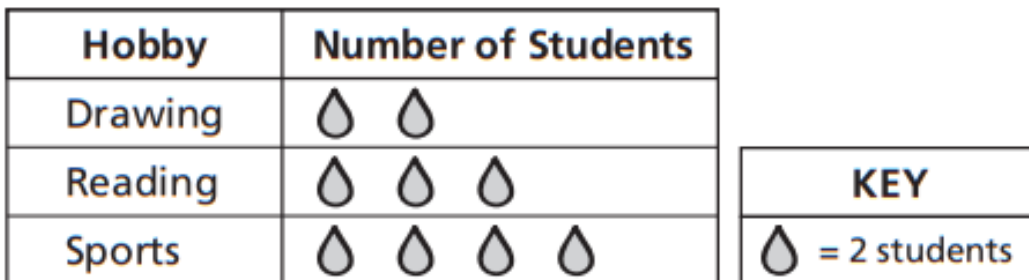

Which table represents the same data as the picture graph?

A

STUDENTS' FAVORITE HOBBIES	
Hobby	Number of Students
Drawing	4
Reading	6
Sports	8

C

STUDENTS' FAVORITE HOBBIES	
Hobby	Number of Students
Drawing	2
Reading	3
Sports	4

B

STUDENTS' FAVORITE HOBBIES	
Hobby	Number of Students
Drawing	8
Reading	6
Sports	4

D

STUDENTS' FAVORITE HOBBIES	
Hobby	Number of Students
Drawing	4
Reading	5
Sports	6

3. An art teacher is planning a painting project for her classes. She made the table below to show how much paint she would need for each class.

PAINT FOR ONE CLASS

Color	Amount Needed (pints)
Red	4
Yellow	2
Blue	3

What is the total number of pints of paint that will be needed for her five classes?

Show your work.

Answer _____ pints

4. Several students voted on their favorite sports activities.

- Eight students voted for basketball.
- Three students voted for volleyball.
- Seven students voted for baseball.
- Four students voted for kickball.

Complete the picture graph below to show the data.

FAVORITE SPORT ACTIVITY

Activity	Number of Students
Basketball	
Volleyball	
Baseball	
Kickball	

KEY
 = 2 students

5. Ms. Amani and Mr. Blake each ordered supplies for their classrooms. The cost of the supplies is shown below.

CLASSROOM SUPPLIES

Supply	Cost
Pencil Case	\$3
Box of Crayons	\$4
Pack of Folders	\$2

Ms. Amani ordered 7 pencil cases and 9 packs of folders. Mr. Blake ordered 9 boxes of crayons. What is the difference in the cost of the supplies Ms. Amani ordered and the cost of the supplies Mr. Blake ordered?

Show your work.

Difference in cost \$_____

EVEN STEVEN

Everyone has a partner.

2 8

4 10

6

Odd TODD

Not everyone has a partner.

1 7

3 9

5

Look in the ones
place to tell if
 it's even or odd!

 Even <small>All In Pairs</small>	Odd <small>Not All In Pairs</small> 
0	1
2	3
4	5
6	7
8	9

Primary Source, LLC ©2009 All Rights Reserved

psteacherresources.com

Count the items in each group. Tell whether there is an odd number or even number of each object.



How many? 11

Odd or even? odd



How many? _____

Odd or even? _____



How many? _____

Odd or even? _____

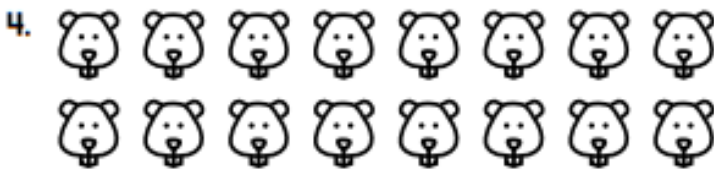

How many? _____

Odd or even? _____



How many? _____

Odd or even? _____



How many? _____

Odd or even? _____



How many? _____

Odd or even? _____

1. Leslie says that 5 multiplied by an even number always results in an even product. Is Leslie's statement correct?

Explain your answer.

2. Which statement is true?

- A** The product of 5×2 is even because both of the factors are even.
- B** The product of 4×4 is odd because both of the factors are even.
- C** The product of 2×7 is even because both of the factors are odd.
- D** The product of 5×3 is odd because both of the factors are odd.



Day # 3

NYS Math Exam

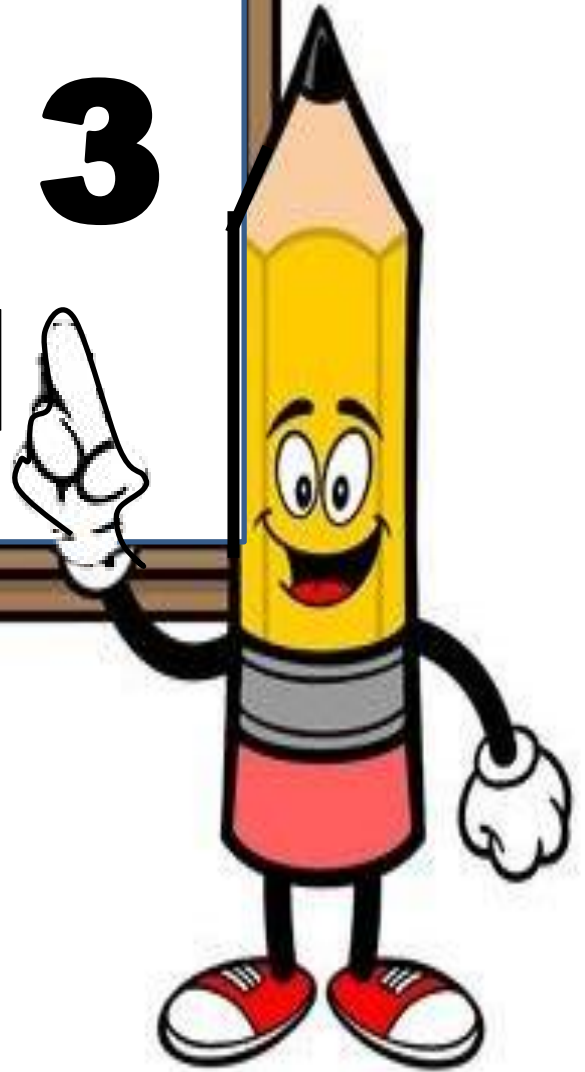



Day # 4

NYS Math Exam Make up Day

Scholars who are not testing will engage in a Jeopardy Review game created by Mrs. Blomgren

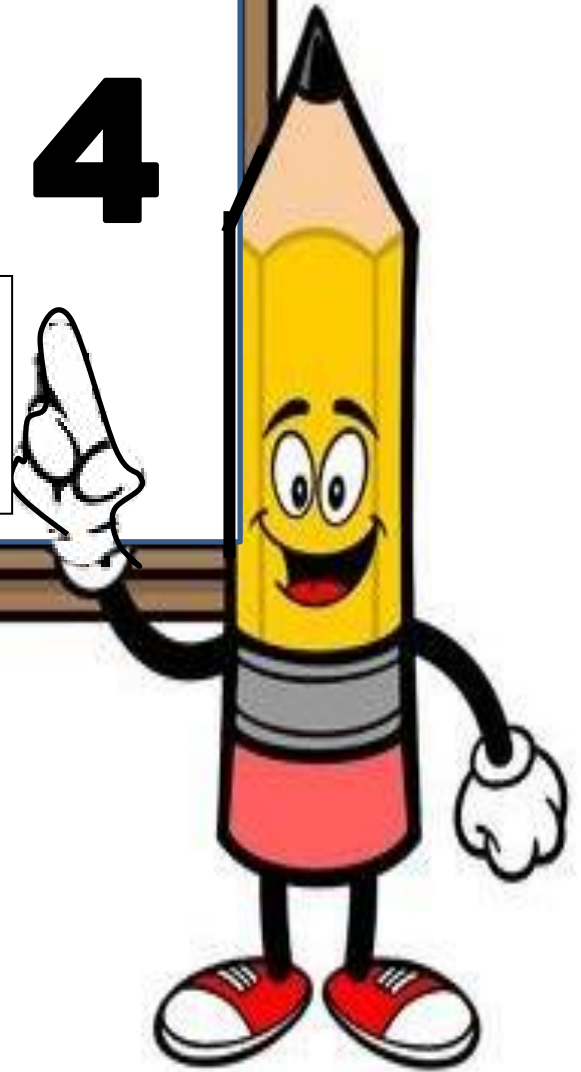



Day # 5

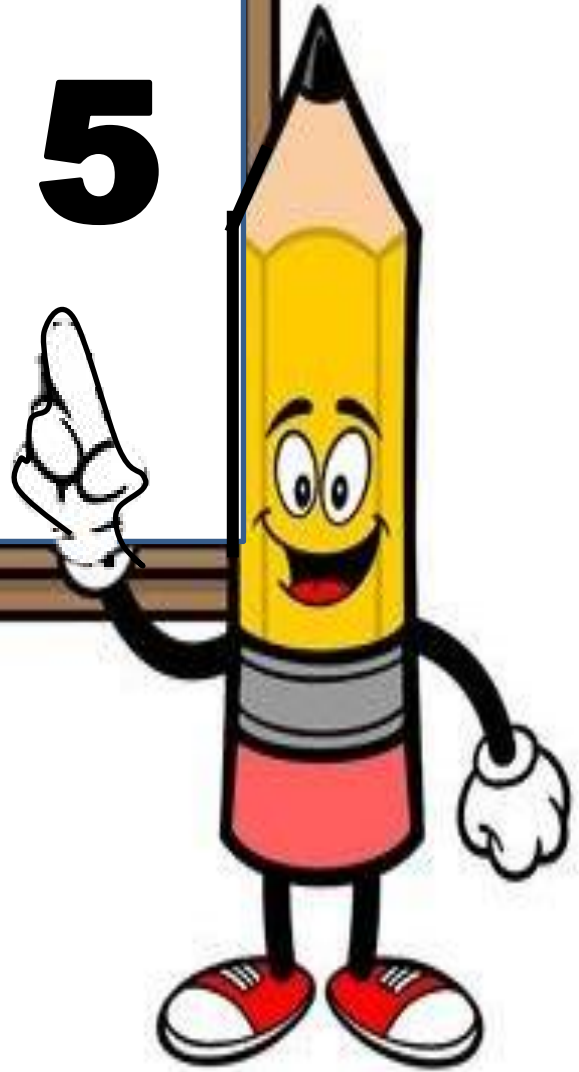

LEQ: How can I explore perimeter as an attribute of plane figures and solve problems?

Objective: I can add side lengths of any given shape to explore perimeter as an attribute of plane figures and solve problems.

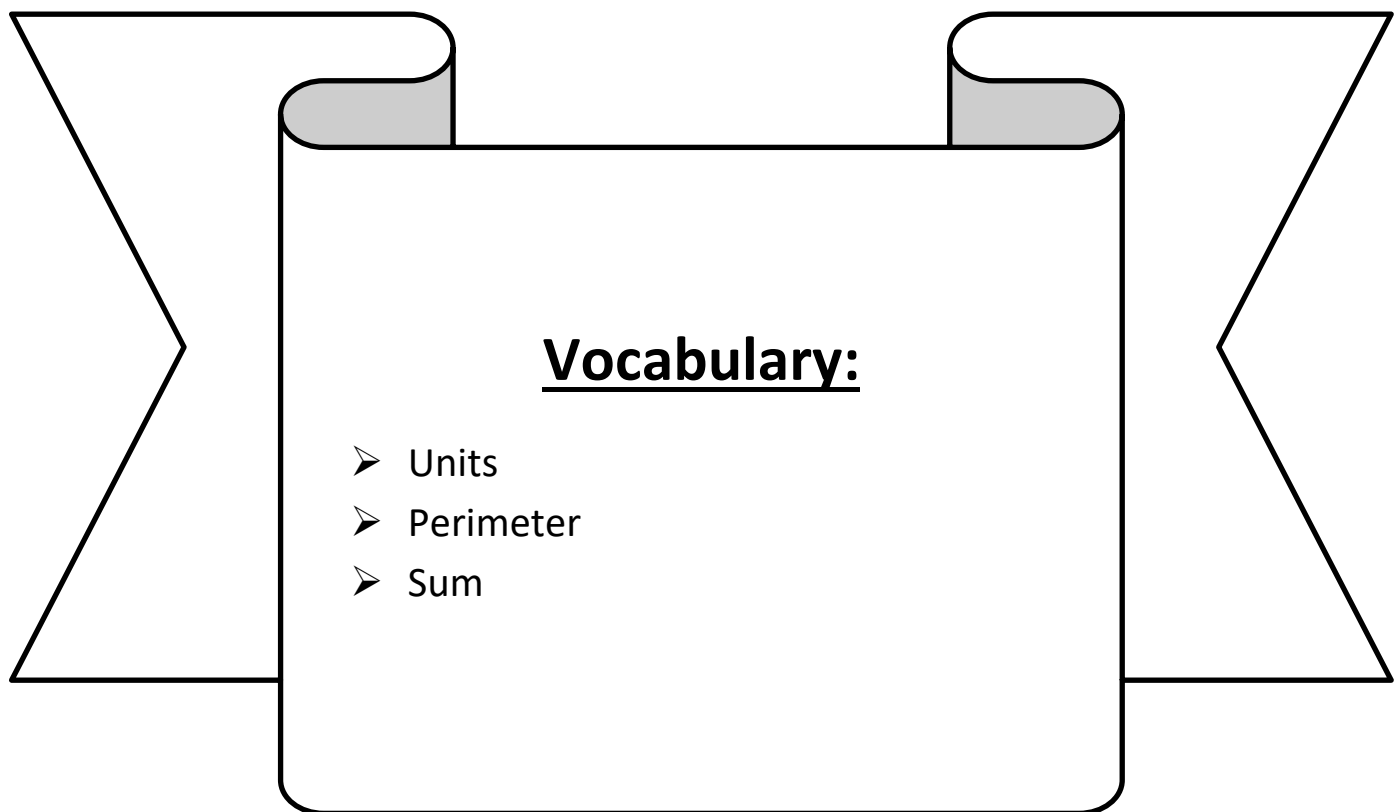

Name: _____

Week 33 Day 5 Date: _____

BCCS-B

Harvard

Yale

Princeton

Exploration:

*Mrs. Mclean wants to put a fence around her back yard.
How much fencing should she buy?*

10 Feet



8 Feet

Name: _____

Week 33 Day 5 Date: _____

BCCS-B

Harvard

Yale

Princeton

Input (My Turn):

Perimeter

The distance around a shape

This is Perry the Perimeter bug! He loves to run bug races around the bug race track!

5 in.
3 in. 3 in.
5 in.

To find how far Perry runs (the perimeter), add up the sides!
 $5 + 5 + 3 + 3 = 16$ inches around

While the area of a shape is the space that's inside in square units, a shape's

perimeter is the distance around it in the given unit. To find

the **perimeter** of a square with a side length of 4 inches, I would add 4 inches + 4

inches + 4 inches + 4 inches to get a perimeter of _____ inches.

Name: _____

Week 33 Day 5 Date: _____

BCCS-B

Harvard

Yale

Princeton

Input (My Turn):

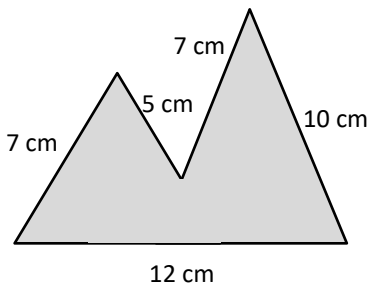
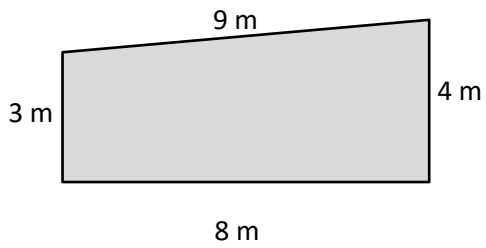
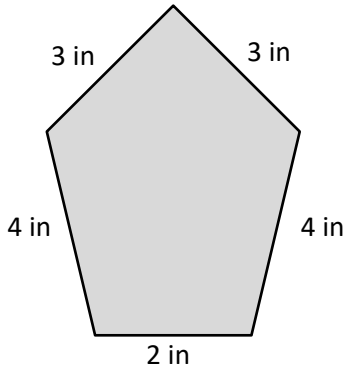

Name: _____

Week 33 Day 5 Date: _____

BCCS-B

Harvard

Yale

Princeton

Problem Set (Your Turn):

1. Find the perimeter of the following shapes.

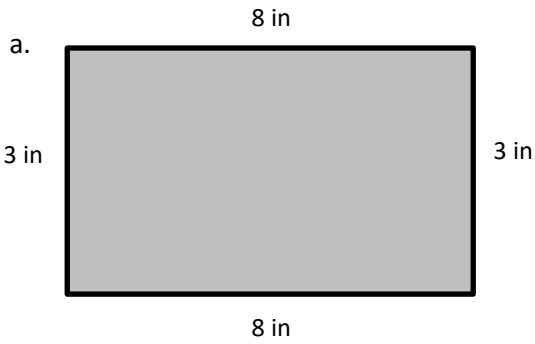

$$P = 3 \text{ in} + 8 \text{ in} + 3 \text{ in} + 8 \text{ in}$$
$$= \underline{\hspace{2cm}} \text{ in}$$

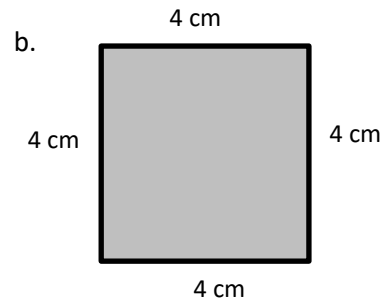

$$P = \underline{\hspace{1cm}} \text{ cm} + \underline{\hspace{1cm}} \text{ cm} + \underline{\hspace{1cm}} \text{ cm} + \underline{\hspace{1cm}} \text{ cm}$$
$$= \underline{\hspace{2cm}} \text{ cm}$$

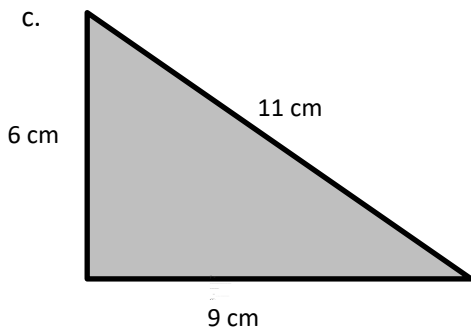

$$P = \underline{\hspace{1cm}} \text{ cm} + \underline{\hspace{1cm}} \text{ cm} + \underline{\hspace{1cm}} \text{ cm}$$
$$= \underline{\hspace{2cm}} \text{ cm}$$

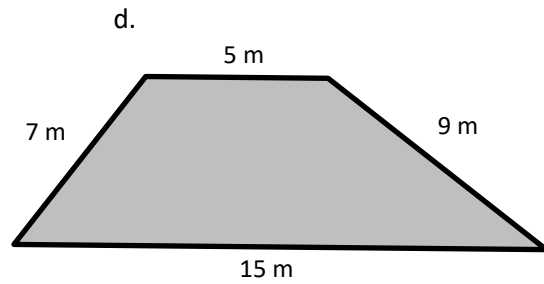

$$P = \underline{\hspace{1cm}} \text{ m} + \underline{\hspace{1cm}} \text{ m} + \underline{\hspace{1cm}} \text{ m} + \underline{\hspace{1cm}} \text{ m}$$
$$= \underline{\hspace{2cm}} \text{ m}$$

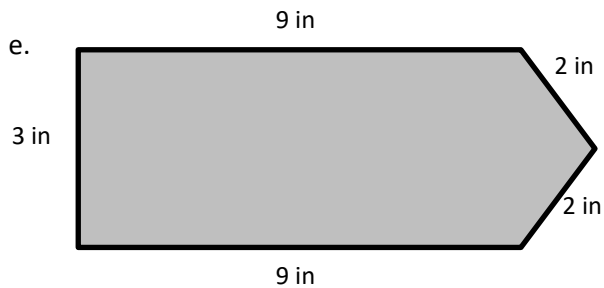

$$P = \underline{\hspace{1cm}} \text{ in} + \underline{\hspace{1cm}} \text{ in} + \underline{\hspace{1cm}} \text{ in} + \underline{\hspace{1cm}} \text{ in} + \underline{\hspace{1cm}} \text{ in}$$
$$= \underline{\hspace{2cm}} \text{ in}$$

Name: _____

Week 33 Day 5 Date: _____

BCCS-B



Harvard

Yale

Princeton

✓ Who/what is this problem about? 

✓ How do we solve this problem? 

✓  Show and check your work completely. 

C Circle key numbers & units
What do I know?

U Underline the question
What am I being asked to solve?

B Box math clue words
Am I going to +, -, x, or ÷?

E Evaluate and Eliminate
What steps do I take?
What information don't I need?

S Solve and Show your work
Does my answer make sense?
How can I double check?

Application:

Which shape below has the greater perimeter? Explain your answer.

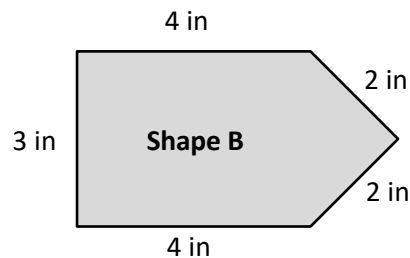
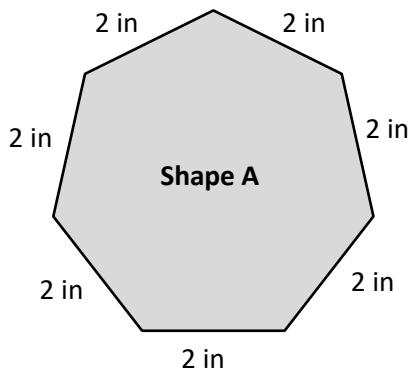

Shape _____ has the greatest perimeter because

Name: _____

Week 33 Day 5 Date: _____

BCCS-B

Harvard

Yale

Princeton

Exit Ticket:

- Find the perimeters of the shapes below. Include the units in your equations. Match the letter inside each shape to its perimeter to solve the riddle. The first one has been done for you.

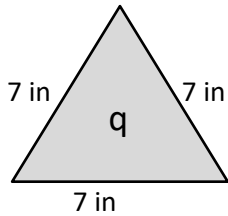

$$P = 7 \text{ in} + 7 \text{ in} + 7 \text{ in}$$

$$P = 21 \text{ in}$$

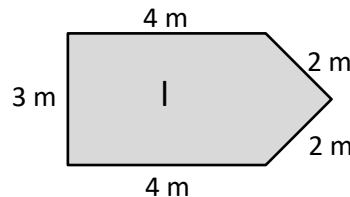
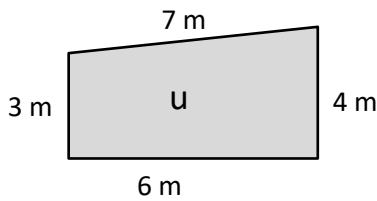
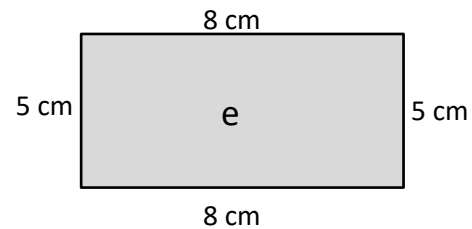
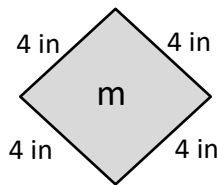
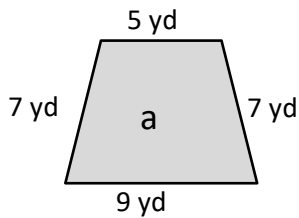
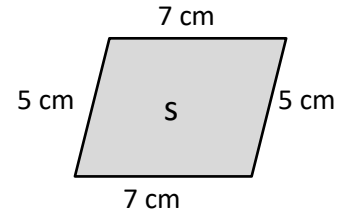
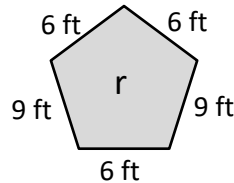

What kind of meals do math teachers eat?

_____ !
 24 21 20 28 36 26 16 26 28 15 24

