



Remote Packet Cover Page

Scholar's Name: _____

Scholar's Grade: Kindergarten

Scholars' College: SUNY Morrisville

Scholar's Teacher: Mrs. Dietzman

Dear Educator,

My signature is proof that I have reviewed my scholar's

_____ work and supported him to the best of
(Insert Scholar's Name)

my ability to complete all assignments.

(Parent Signature)

(Date)

Name: _____

BCCS- Boys

Directions: Write how many objects you see in each box.

Date: September 8, 2020

College: SUNY Morrisville

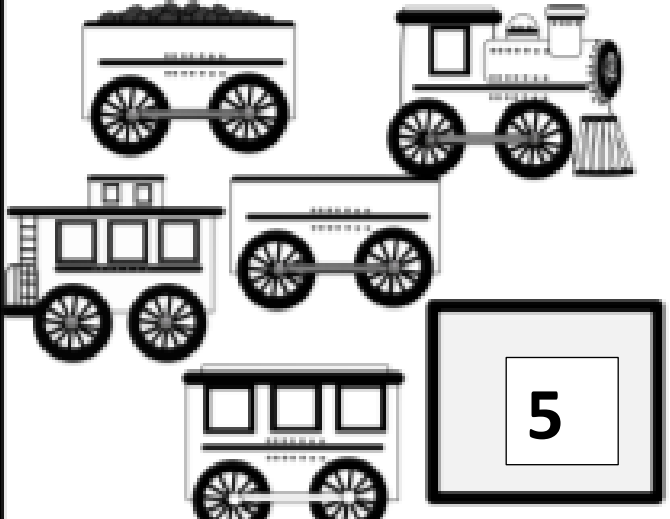

5

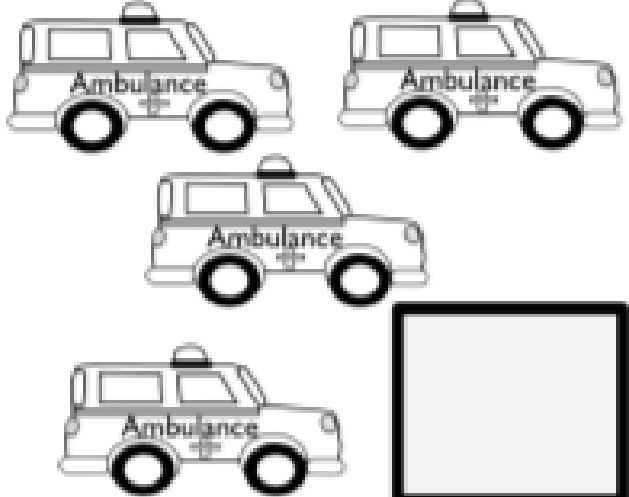
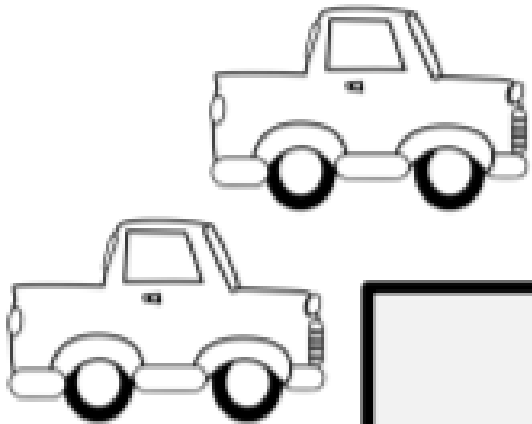
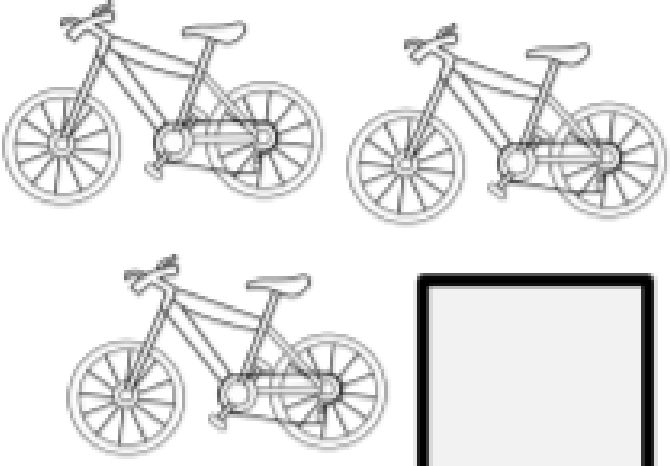
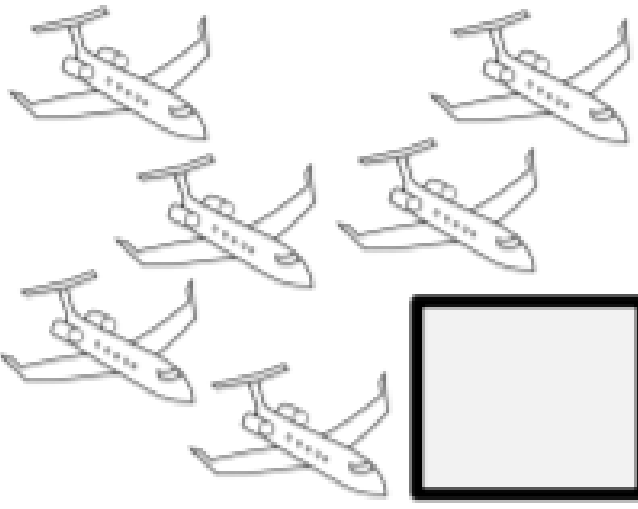
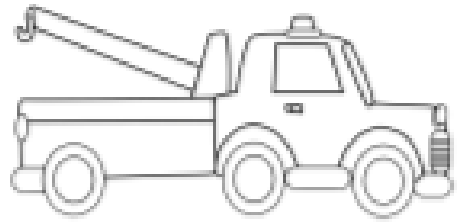

Reading Comprehension

Read the short passage and answer the questions.

Fluffy the Cat

Fluffy is a cat. She likes to play. Fluffy can jump very high.

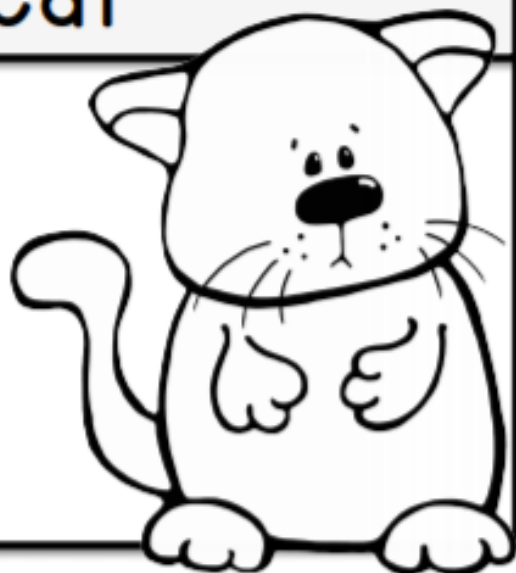

1. What kind of animal is Fluffy?

- dog
- cat

2. What does she like to do?

- play
- jump

3. What can Fluffy do?

- jump high
- walk

Directions: Match the beginning sound with the picture.



P W X



l r c



k v s



y s m



m o d



v n p



p f a



d l z



y i m

This Summer I...

WENT

spent time with

Had so much fun

By:

Learned

Mp



Remote Packet Cover Page

Scholar's Name: _____

Scholar's Grade: Kindergarten

Scholars' College: SUNY Morrisville

Scholar's Teacher: Mrs. Dietzman

Dear Educator,

My signature is proof that I have reviewed my scholar's

_____ work and supported him to the best of
(Insert Scholar's Name)

my ability to complete all assignments.

(Parent Signature)

(Date)

Reading Comprehension

Read the short passage and answer the questions.

Football

Lou plays football. He loves football. Lou can run fast and throw far. He will ask Jon to play with him.



1. What does Lou play?

- games
- football
- soccer

2. What can Lou do?

- run fast
- jump high
- score

3. What will he do?

- wear a hat
- run fast
- ask Jon to play

Letter Review

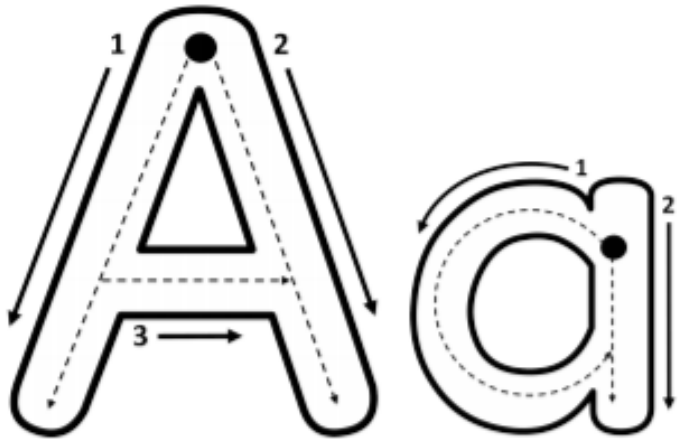

Find the letter

V	A	a	G
a	F	A	A
A	a	N	a
a	d	f	A



Color all the pictures with this letter sound.



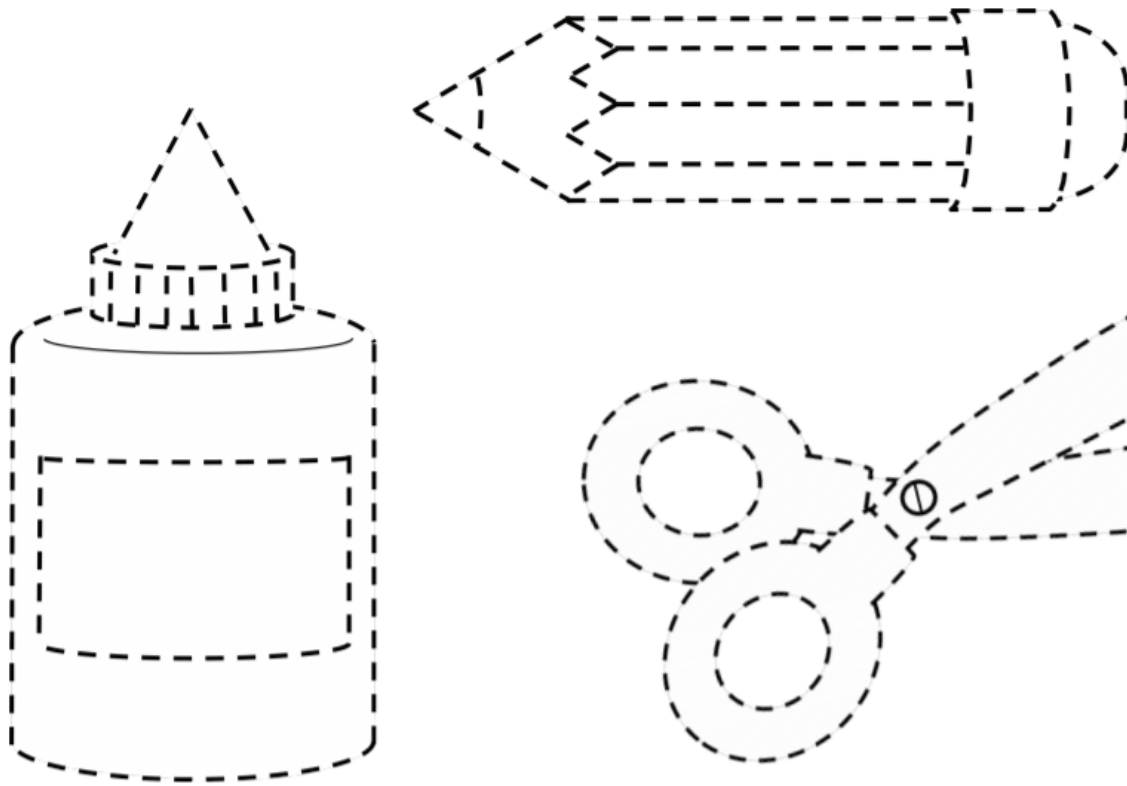

Back to School



Remote Packet Cover Page

Scholar's Name: _____

Scholar's Grade: Kindergarten

Scholars' College: SUNY Morrisville

Scholar's Teacher: Mrs. Dietzman

Dear Educator,

My signature is proof that I have reviewed my scholar's

_____ work and supported him to the best of
(Insert Scholar's Name)

my ability to complete all assignments.

(Parent Signature)

(Date)





Name: _____

BCCS- Boys

Date: September 10, 2020

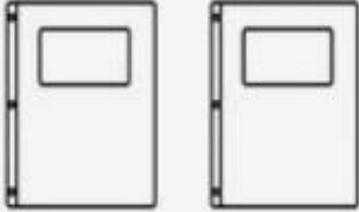
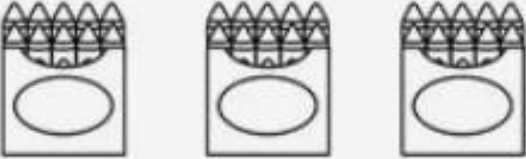
College: SUNY Morrisville

Directions: Color the number to show how many.

	1 2 3
	3 4 2
	5 3 4
	2 1 3
	3 4 5

Reading Comprehension

Read the short passage and answer the questions.

My Friend

My friend's name is Ben.
Ben is a great friend. He is
five years old. Ben plays
soccer. We have so much
fun together!













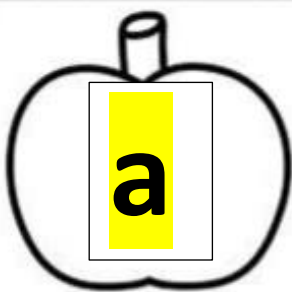







1. What is my friend's name?

2. How old is he?

3. What does he play?

Apple Letter Match

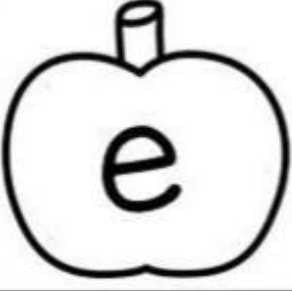
Color the matching lower case letter.

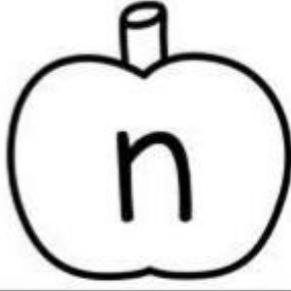
Write your name with a



Handwriting practice lines consisting of a solid top line, a dashed middle line, and a solid bottom line.



Handwriting practice lines consisting of a solid top line, a dashed middle line, and a solid bottom line.



Handwriting practice lines consisting of a solid top line, a dashed middle line, and a solid bottom line.



Remote Packet Cover Page

Scholar's Name: _____

Scholar's Grade: Kindergarten

Scholars' College: SUNY Morrisville

Scholar's Teacher: Mrs. Dietzman

Dear Educator,

My signature is proof that I have reviewed my scholar's

_____ work and supported him to the best of
(Insert Scholar's Name)

my ability to complete all assignments.



(Parent Signature)

(Date)

Name: _____
BCCS- Boys

Date: September 11, 2020
College: SUNY Morrisville

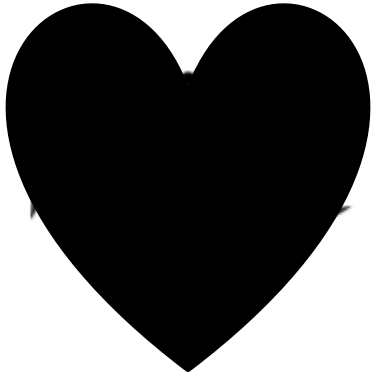
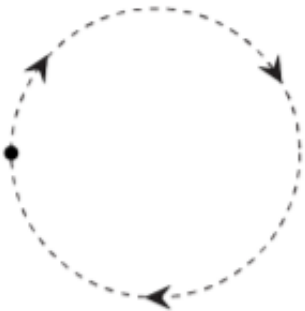
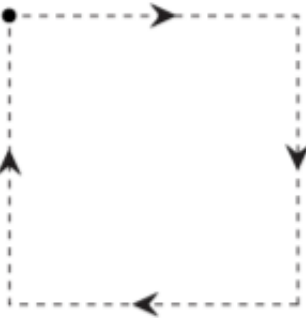
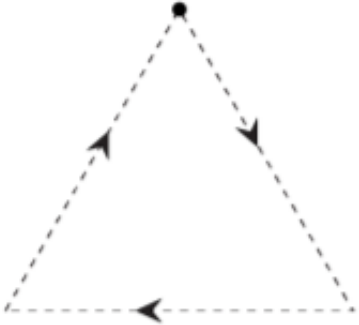
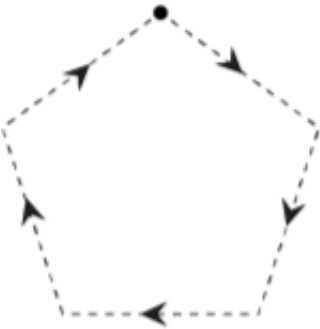
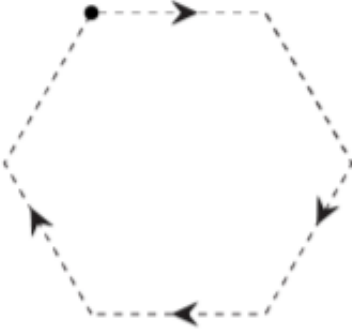
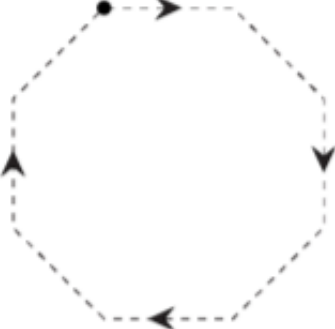
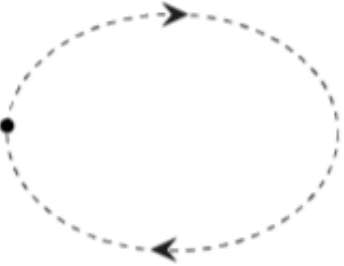
Directions: Trace the shapes.

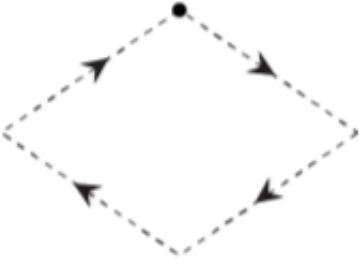
<h1>Shapes</h1>		
		
		
		

CVC COMPREHENSION

Read the passage 3 times and color the stars. Color the -ad words. Answer the questions.

dad had pad bad sad

Dad's Pad

**Dad had a pad.
He did not find the pad.
It was bad.
Dad was sad.**



1 Dad had a ____.



2 Dad did not find the ____.

- bad
- pad
- bat

3 Dad was ____.

- fat
- mad
- sad

Alphabet Uppercase Letters

Write the uppercase letters.

A A

B

C

D

E

F

G

H

I

J

K

L

M

N

O

P

Q

R

S

T

U

V

W

X

Y

Z

Directions: Trace and color the school supplies.

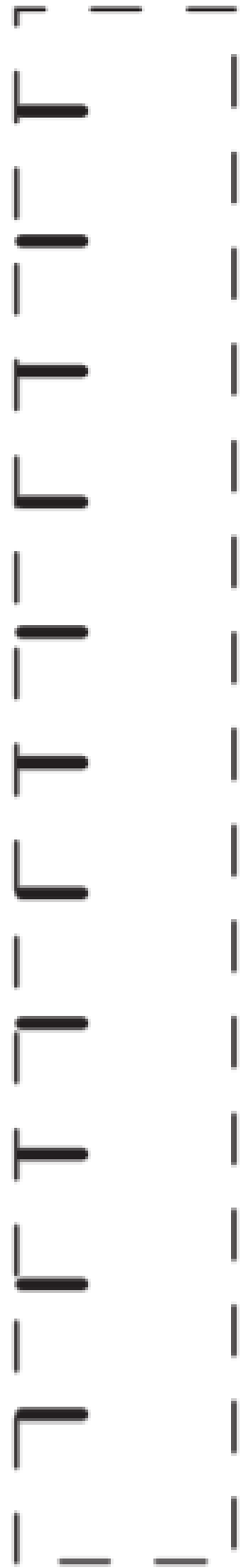
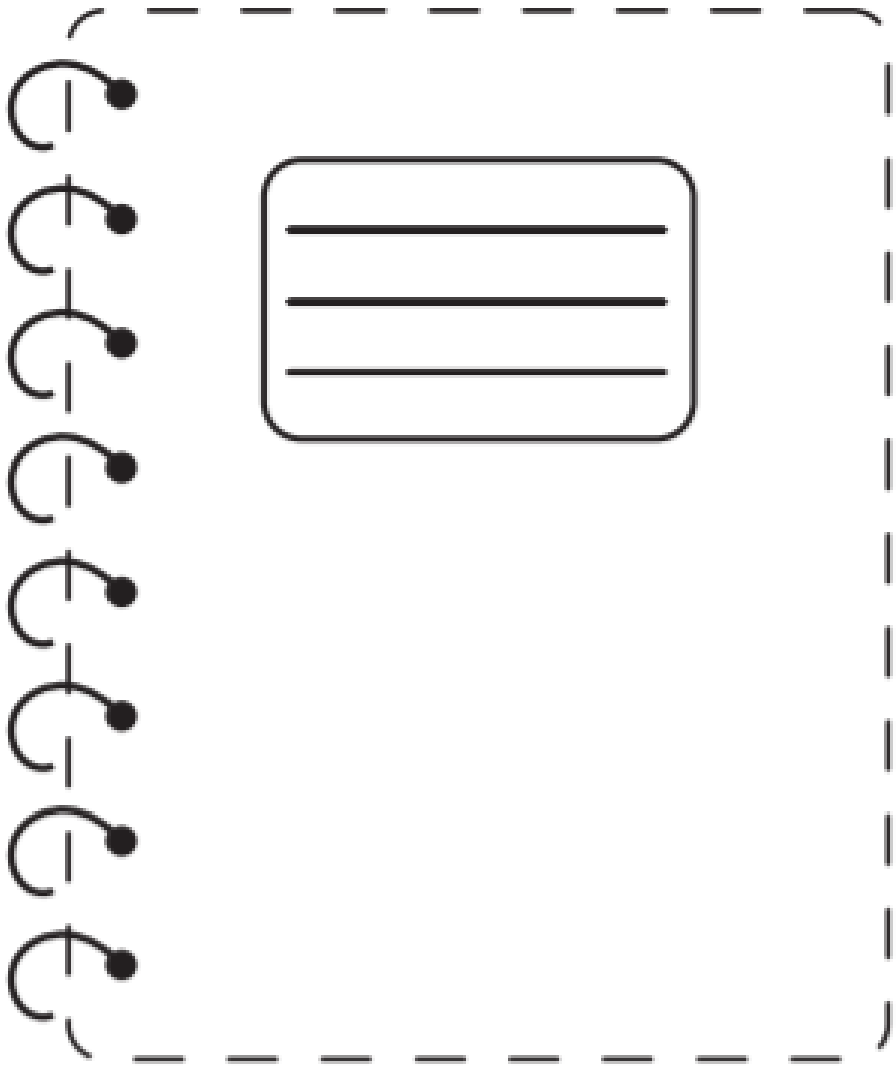



Remote Packet Cover Page

Scholar's Name: _____

Scholar's Grade: Kindergarten

Scholars' College: SUNY Morrisville

Scholar's Teacher: Mrs. Dietzman

Dear Educator,

My signature is proof that I have reviewed my scholar's

_____ work and supported him to the best of
(Insert Scholar's Name)

my ability to complete all assignments.

(Parent Signature)

(Date)

Name: _____
BCCS- Boys

Date: September 14, 2020
College: SUNY Morrisville

Tracing numbers 1-5

Directions: Trace all the numbers.

1

1

1

1

1

2

2

2

2

2

3

3

3

3

3

4

4

4

4

4

5

5

5

5

5

CVC COMPREHENSION

Read the passage 3 times and color the stars. Color the -en words. Answer the questions.

men ten hen den pen

Men And Hen

The men have ten hen.
The hen are not in the den.
The hen are in the pen.



1 The men have: hen ten pen

2 There are
_____ hen:
 one
 three
 ten

3 The hen are
in the:
 pen
 den
 ben

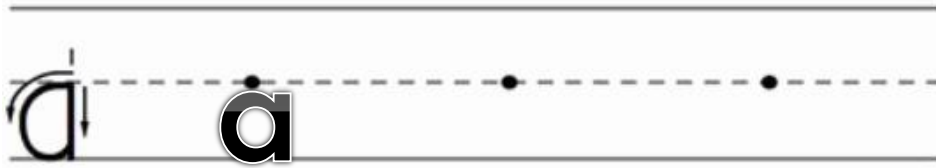

Color It



Trace It.

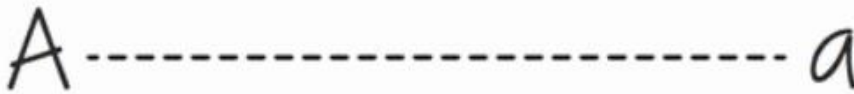

Circle It

Match It

ant

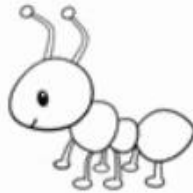

apple



ax



a E l a

a g A K

p A c u

A z S a

THESE ARE MY FAVORITES



Favorite color



Favorite book



Favorite snack



Favorite season



Favorite animal



Favorite movie





Remote Packet Cover Page

Scholar's Name: _____

Scholar's Grade: Kindergarten

Scholars' College: SUNY Morrisville

Scholar's Teacher: Mrs. Dietzman

Dear Educator,

My signature is proof that I have reviewed my scholar's

_____ work and supported him to the best of
(Insert Scholar's Name)

my ability to complete all assignments.

(Parent Signature)

(Date)

Name: _____
BCCS- Boys

Date: September 15, 2020
College: SUNY Morrisville

Tracing numbers 6-10

Directions: Trace all the numbers.

6

6

6

6

6

7

7

7

7

7

8

8

8

8

8

9

9

9

9

9

10

10

10

10

10

Read the passage 3 times and color the stars. Color the -ig words. Answer the questions.

pig wig dig

My Pig

**Can you see my pig?
My pig has a wig.
And it likes to dig.**



1 I have a ____.



2 My pig has a ____.

- fig**
- rig**
- wig**

3 My pig likes to:

- dig**
- fig**
- wig**

Match the Alphabets with the object with the same starting Alphabet

V



U



Y

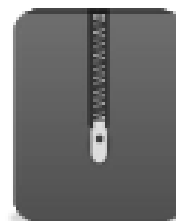

W



X



Z

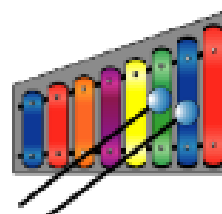

★ ★ ★ This is Me! ★ ★ ★

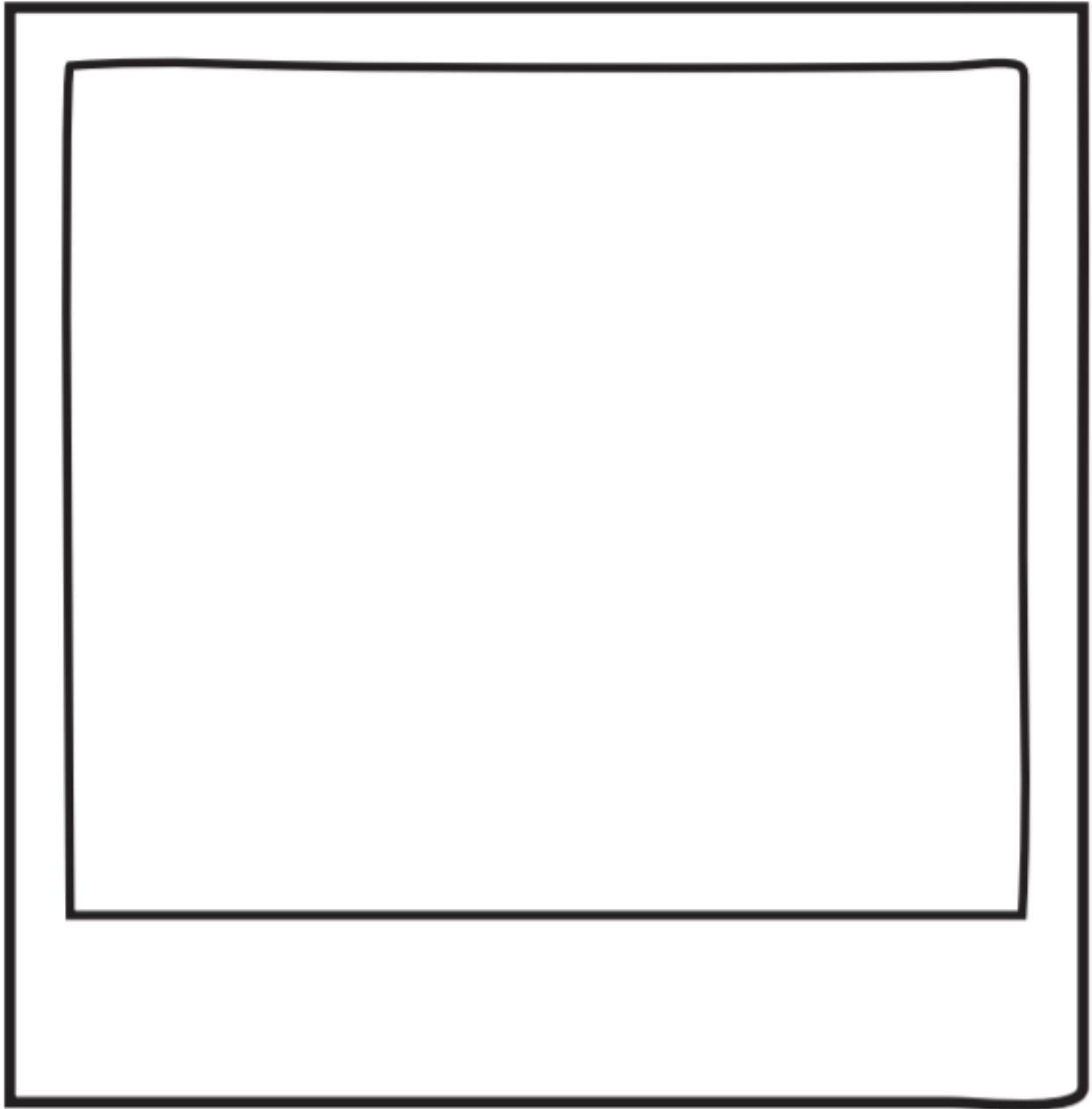

I have _____ color
and _____ color





Remote Packet Cover Page

Scholar's Name: _____

Scholar's Grade: Kindergarten

Scholars' College: SUNY Morrisville

Scholar's Teacher: Mrs. Dietzman

Dear Educator,

My signature is proof that I have reviewed my scholar's

_____ work and supported him to the best of
(Insert Scholar's Name)

my ability to complete all assignments.

(Parent Signature)

(Date)

Name: _____
BCCS- Boys



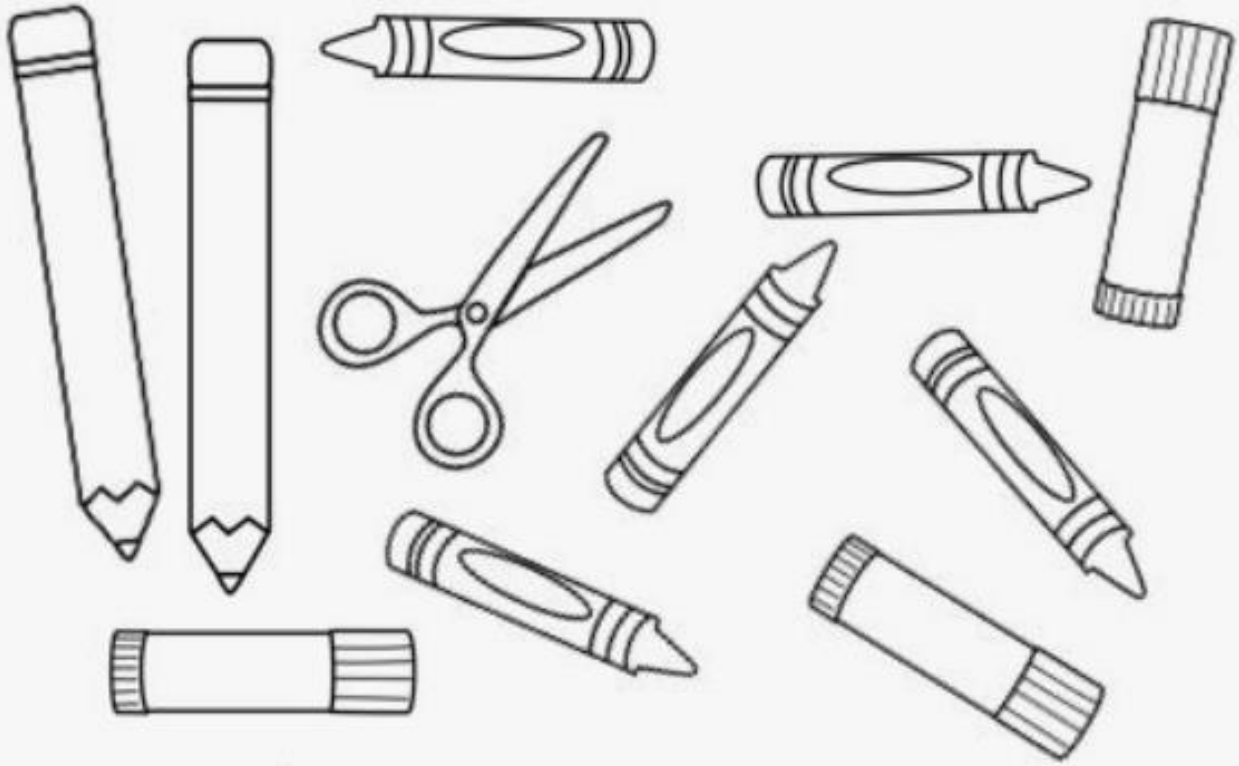

Date: September 16, 2020
College: SUNY Morrisville

Back To School

Color, count, and graph.



How many? Color the graph.

	■	■	■		
					
					
					

Read the passage 3 times and color the stars. Color the -og words. Answer the questions.

dog hog jog fog

The Dog And The Hog

**My dog can jog.
My hog can jog.
They jog in the fog.**

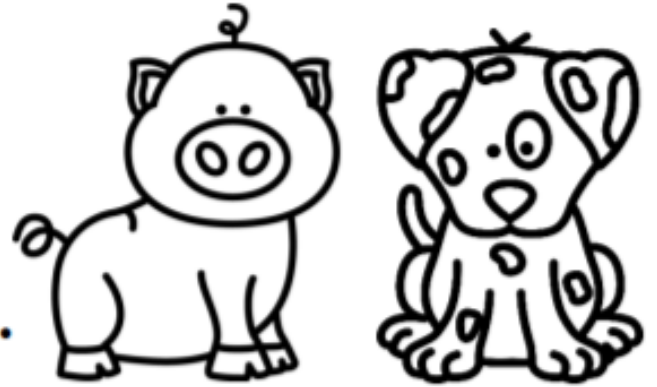

1 I have a ___ and a ___ :



2 The dog can ___.

- hog
- jog
- fog

3 The dog and the hog jog in the ___.

- fog
- log
- frog

Letter Review

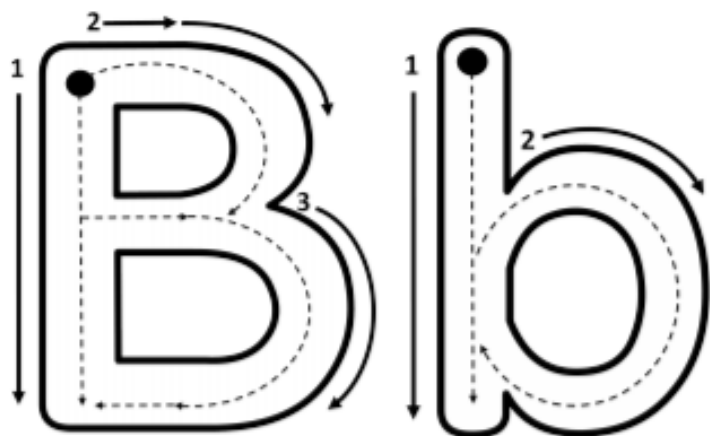

Find the letter

b	D	B	b
t	B	b	G
s	b	Q	B
B	r	B	b

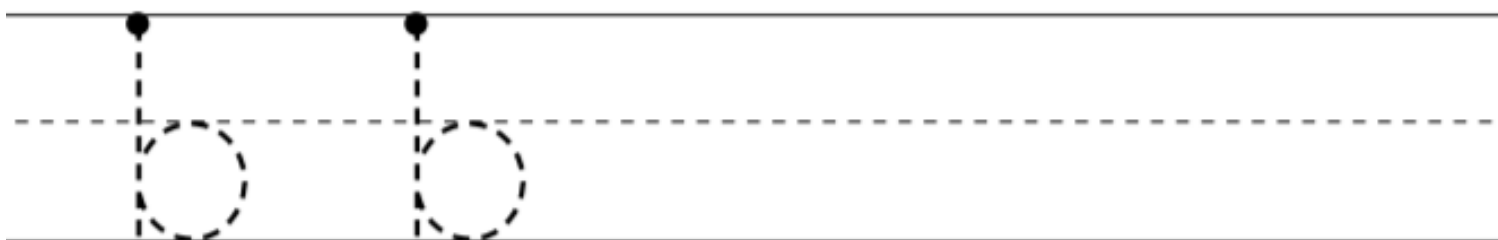
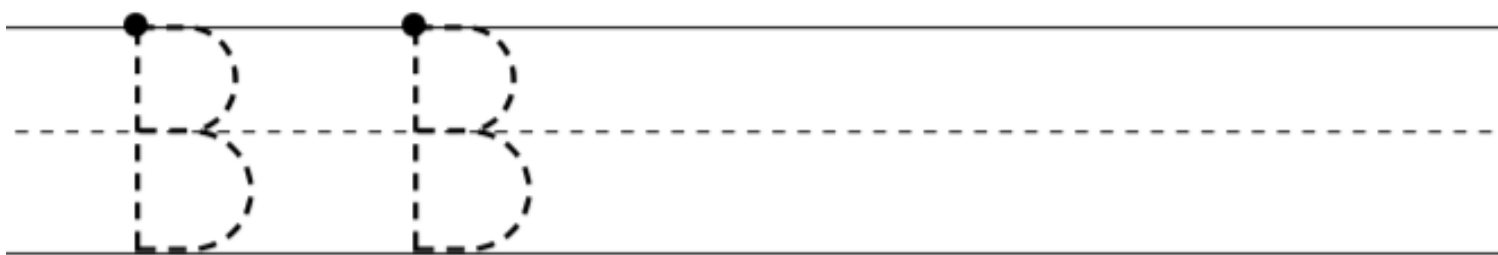

Color all the pictures with this letter sound.



Color by Number

Directions: Use the code to color the picture.

- 1 - Green 2 - Red
3 - Yellow 4 - Blue
5 - Brown 6 - Black

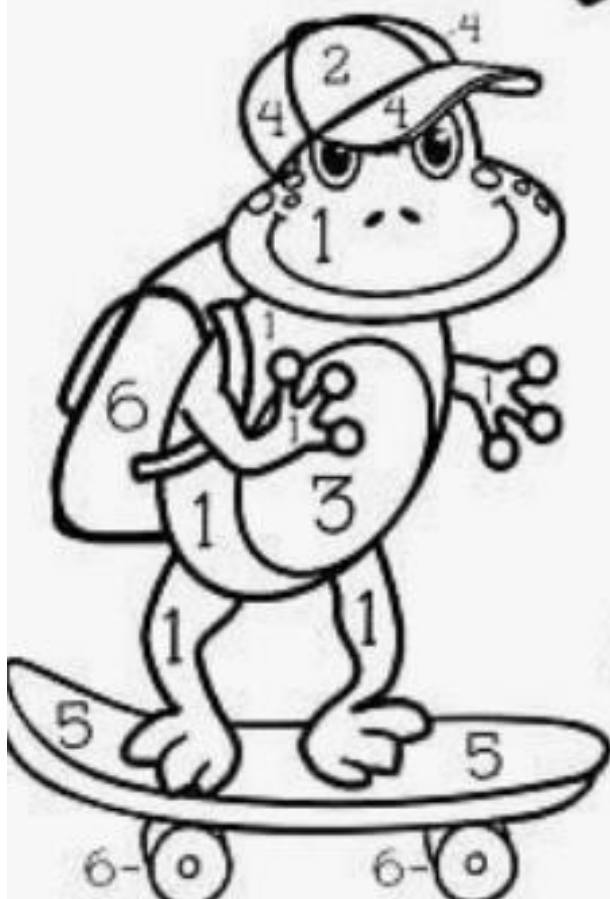



Remote Packet Cover Page

Scholar's Name: _____

Scholar's Grade: Kindergarten

Scholars' College: SUNY Morrisville

Scholar's Teacher: Mrs. Dietzman

Dear Educator,

My signature is proof that I have reviewed my scholar's

_____ work and supported him to the best of
(Insert Scholar's Name)

my ability to complete all assignments.

(Parent Signature)

(Date)

Color the Amount

Color the correct number of objects for each number.

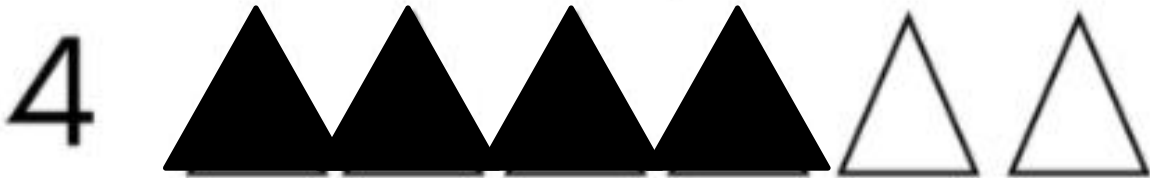

FUN FACT: These are all different SHAPES. Can you name the shapes you just colored in?

Read the passage 3 times and color the stars. Color the -ug words. Answer the questions.

Dot pot hot bot

Pug's Bug

The pug has a bug.
The bug has a mug.
It naps in a jug.
It likes to hug the pug.



1 The bug has a ____.



2 The bug naps in a ____.

- rug
- mug
- jug

3 The bug likes to ____ the pug.

- hug
- jug
- rug

Match the Alphabets with the object with the same starting Alphabet

D



c

B



b

E



d

A



a

C



e

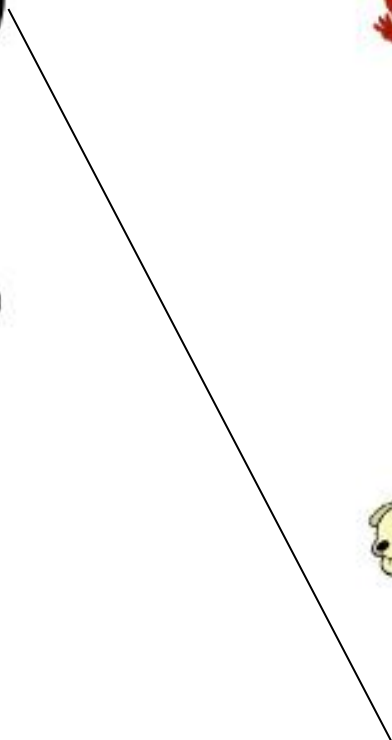

Color the letters that appear in your name.

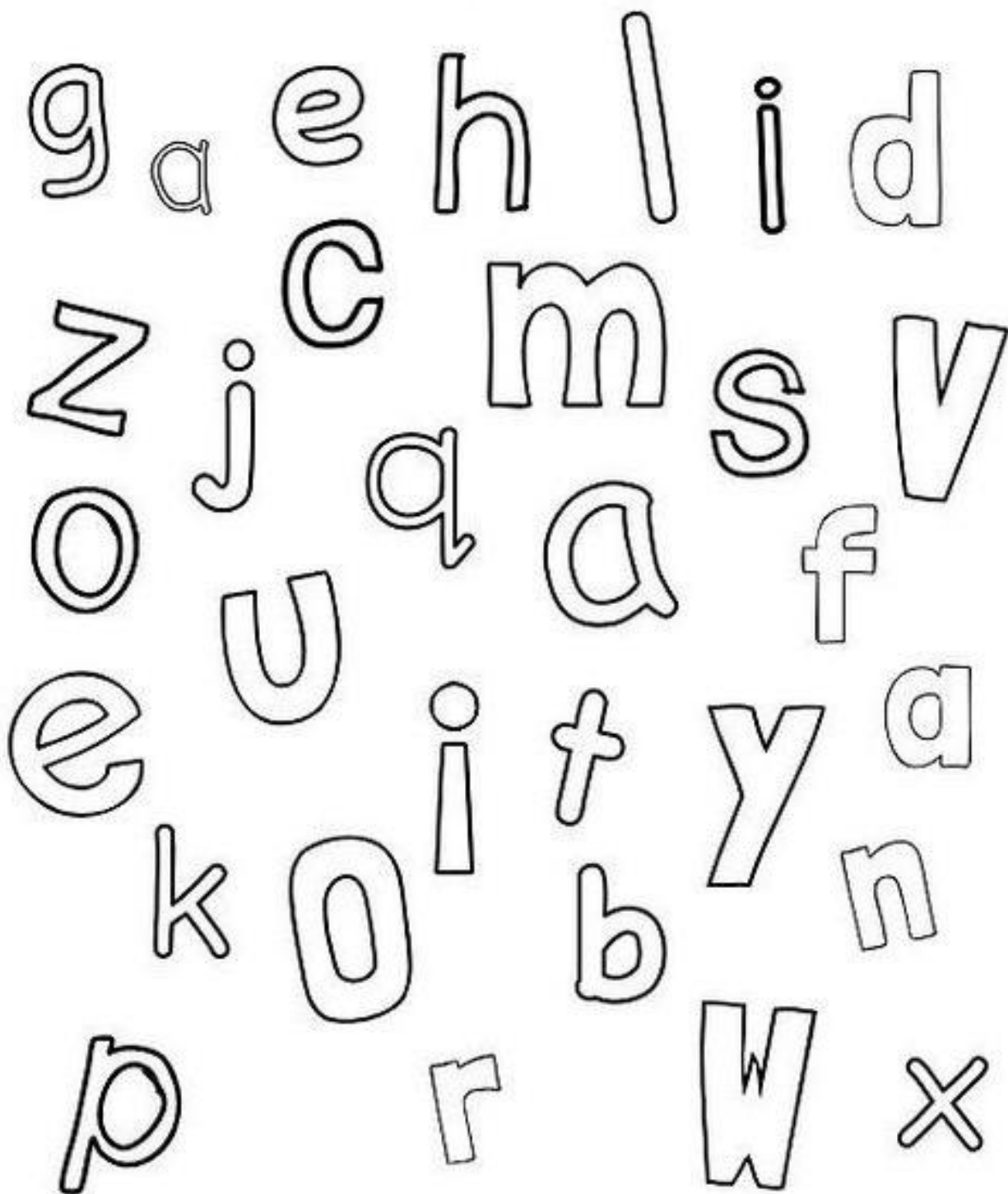



Remote Packet Cover Page

Scholar's Name: _____

Scholar's Grade: Kindergarten

Scholars' College: SUNY Morrisville

Scholar's Teacher: Mrs. Dietzman

Dear Educator,

My signature is proof that I have reviewed my scholar's

_____ work and supported him to the best of
(Insert Scholar's Name)

my ability to complete all assignments.

(Parent Signature)

(Date)

Name: _____
BCCS- Boys

Date: September 18, 2020
College: SUNY Morrisville

Tracing Numbers 0 Through 9

0	0	0	0	0	0	0	0
1	1	1	1	1	1	1	1
2	2	2	2	2	2	2	2
3	3	3	3	3	3	3	3
4	4	4	4	4	4	4	4
5	5	5	5	5	5	5	5
6	6	6	6	6	6	6	6
7	7	7	7	7	7	7	7
8	8	8	8	8	8	8	8
9	9	9	9	9	9	9	9

-um

Yum! I Like Gum!

Yum! I like gum!

I like to chew gum.

I like to chew gum and hum.

My mum has gum.

She gives me some.

Yum! Yum!

I like to chew gum!



1. I like _____.

- plums
- gum
- buns

2. I like to chew and _____.

- run
- play
- hum

3. She gives me _____.

- some
- plums
- jam

4. Who has gum?

.....

Match the Alphabets with the object with the same starting Alphabet

I



h

G



g

J



i

F



f

H



j



This is how
I write my name.

Name _____

This is how
I write my age.

Age _____
